

MONITOR WITH RECEIVER

# DMX8020DABS DMX7520DABS

## INSTRUCTION MANUAL

JVCKENWOOD Corporation

- Updated information (the latest Instruction Manual, system updates, new functions, etc.) is available from <https://www.kenwood.com/cs/ce/>.
- The Instruction manual is subject to change for modification of specifications and so forth. Be sure to download the latest edition of the Instruction manual for reference. <http://manual.kenwood.com/edition/im404/>



**android  
auto**



The product with the Hi-Res Audio logo is conformed to Hi-Res Audio standard defined by Japan Audio Society. The logo is used under license from Japan Audio Society.



## Important Notice on Software

### Software License on This Product

The software embedded in this product comprises a number of independent software components, each of which is copyrighted by JVCKENWOOD Corporation or by a third party. This product uses software components that are based on an End-User License Agreement (hereinafter called "EULA") stipulated by JVCKENWOOD Corporation and by third parties. The EULA dictates the availability of the source codes of free-software components as a prerequisite to distributing them in executable form under the terms of the GNU General Public License or the Lesser General Public License (hereinafter called "GPL/LGPL"). To get information about the software components that are subject to the terms of the GPL/LGPL, please visit the following Website:

Website URL <https://www2.jvckenwood.com/gpl/>

Queries concerning the contents of the source code or the like will not be accepted.

Please note that software components based on a EULA that is not subject to the terms of the GPL/LGPL or those that have been developed or created by JVCKENWOOD Corporation will be excluded from the scope of source code disclosure.

Because licenses to use software components distributed under the GPL/LGPL are offered to the customers for free of charge, no warranty is granted to the customers, whether explicitly or implicitly, to the extent of the applicable laws. Unless otherwise stipulated by the applicable laws or agreed upon in writing, the copyright holders or those who are entitled to modify and redistribute the software components are not held responsible for any and all damages resulting from their use or from inability to use them. For more information about the terms of use of the software components, required items of compliance and so on, please refer to the GPL/LGPL.

Customers wishing themselves to use a software component that is subject to the GPL/LGPL embedded in this product are encouraged to read the terms of the corresponding license before use. Because each individual license is prescribed by a third party other than

JVCKENWOOD Corporation, the original (English) of the license is presented.

## EULA

### Software License Agreement

JVCKENWOOD Corporation (hereinafter called "Licensor") holds either the copyright to the embedded software or the right to sublicense it. This agreement establishes the conditions under which the customer uses this "Licensed Software."

The customer shall agree to the terms of this license agreement before proceeding to use Licensed Software.

This agreement is deemed to have taken effect when the customer (hereinafter called "User") has used a product implementation of Licensed Software.

The Licensed Software may contain software Licensor has been licensed to use by third parties directly or indirectly. Some third parties may have terms of use prescribed for their customers, apart from this Software License Agreement. This agreement does not apply to such software. Be sure to consult "Important Notice on Software" as presented separately.

#### Article 1 (General)

Licensor grants to User a non-exclusive, non-assignable right of use Licensed Software within the country where the User purchases the Product (hereinafter the "Country") (except for the exception provided for in Paragraph 1, Article 3).

#### Article 2 (Right of Use)

1. The rise of use granted under this agreement is the right to use Licensed Software in this product.
2. User may not duplicate, copy, modify, add to, translate or otherwise alter, or loan licensed Software and the associated literature in whole or in part.
3. Use of Licensed Software is limited to a private extent, and Licensed Software may not be distributed, licensed or sublicensed for any purposes whatsoever, including commercial use.
4. User shall use Licensed Software as per the instruction manual or instructions given in the help file and may not use or duplicate data in violations of the regulations of the Copyright Law or other governing laws by using Licensed Software in whole or in part.

### **Article 3 (Terms of License)**

1. In assigning this product, User may not retain the original copy of the embedded Licensed Software (including associated literature, updates and upgrades) and any duplicates and associated literature with regard to the license to use Licensed Software. User may transfer Licensed Software only to the condition of binding the assignee to abide by the terms of this Software License Agreement.
2. User may not reverse-engineer, disassemble, decompile or otherwise analyze the source code of Licensed Software.

### **Article 4 (Rights to Licensed Software)**

All rights to Licensed Software and the associated literature, including copyrights, shall reside with Licensor or the original right holder who has granted the Right of Use and right to sublicense to Licensor (hereinafter referred to as "Original Right Holder"), and User does not have any rights other than Right of Use granted hereunder with regard to Licensed Software and the associated literature.

### **Article 5 (Exemption Granted to Licensor)**

1. Licensor and Original Right Holder do not assume any responsibility for damages caused to User or third parties resulting from the exercise by User of the license granted hereunder, unless otherwise provided by any law to the contrary.
2. Licensor does not warrant Licensed Software to be merchantable, compatible and fit for specific purposes.

### **Article 6 (Responsibility for Third Parties)**

If disputes over the infringement of third parties' intellectual property rights, such as copyrights and patent rights, arise out of the use of Licensed Software by User, User shall resolve these disputes at User's own expenses while keep Licensor and Original Right Holder harmless.

### **Article 7 (Secrecy Obligation)**

User shall keep confidential Licensed Software provided hereunder, information contained in the associated literature or the like and those provisions of this agreement not yet in public knowledge and may not disclose or leak these to third parties without prior written consent from Licensor.

### **Article 8 (Cancellation of the Agreement)**

Licensor reserves the right to cancel this agreement forthwith and claim compensation from User for the damages caused by such cancellation when User:

- (1) Breaches any of the provisions of this agreement, or
- (2) Has received a petition for seizure, provisional seizure, provisional disposition or any other kind of compulsory execution.

### **Article 9 (Destruction of Licensed Software)**

If this agreement is terminated under the provision of the foregoing paragraph, User shall destroy Licensed Software, along with all associated literature and its duplicates, within two (2) weeks from the date of termination.

### **Article 10 (Copyright Protection)**

1. Copyrights and all other intellectual property rights relating to Licensed Software shall reside with Licensor and Original Right Holder and in no circumstances with User.
2. User shall abide by the laws relating to copyrights and intellectual property rights in using Licensed Software.

### **Article 11 (Export Control)**

1. Licensed Software and the associated literature or the like may not be exported to places outside the Country (including transmission outside the Country over the Internet or the like).
2. User agrees that Licensed Software is subject to export controls imposed by the Country and the United States of America.
3. User agrees to comply with all the international and domestic laws that apply to this software (U.S. Export Administration Regulations and regulations established by the U.S., the Country and their governmental agencies regarding usage by end users and export destinations).

### **Article 12 (Miscellaneous)**

1. Even if this agreement is invalidated in part by law, all other provisions shall remain in effect.
2. Licensor and User shall consult each other in good faith to resolve any matters not provided for in this agreement or questions arising from the interpretation of this agreement.
3. Licensor and User agree that this agreement is governed by the law of Japan and that all disputes involving claims and obligations that may arise out of this agreement will be settled by arbitration at the Tokyo District Court as the court of first instance.

# Contents

## **Before Use 6**

Precautions.....	6
How to read this manual .....	6

## **Basic Operations 7**

Functions of the Buttons on the Front Panel ...	7
Turning on the Unit .....	8
Initial Settings.....	8
Adjusting the volume .....	10
Viewing Angle .....	11
Touch screen operations .....	11
HOME screen descriptions.....	12
Popup menu .....	12
Source selection screen description.....	13
Source control screen descriptions .....	15
List screen .....	16

## **Widget 17**

Widget.....	17
Multi Widget.....	17
Photo Frame Widget .....	19
Widget SETUP .....	19

## **APPS 21**

Wireless Mirroring Operation.....	21
USB Mirroring Operation.....	21
Apple CarPlay Operation.....	23
Android Auto™ Operation .....	26

## **USB 29**

Connecting a USB device .....	29
USB Basic Operation.....	29
Search Operation.....	31

## **iPod/iPhone 32**

Preparation .....	32
iPod/iPhone Basic Operation .....	33
Search Operation.....	34

## **Radio 35**

Radio Basic Operation .....	35
Memory Operation .....	36
Selecting Operation .....	37
Traffic Information .....	37
Radio SETUP .....	38

## **Digital Radio 39**

Digital Radio Basic Operation .....	39
Storing Service in Preset Memory .....	40
Selecting Operation .....	40
Traffic Information .....	41
Digital Radio SETUP.....	42

## **Bluetooth Control 43**

Information for using Bluetooth® devices.....	43
Register the Bluetooth device .....	44
Bluetooth Setup.....	45
Playing the Bluetooth Audio Device .....	47
Using the Hands-Free Unit.....	49
Hands-Free Setup.....	53

## **Other External Components 55**

View Camera .....	55
Use Dashboard Camera.....	57
External audio/video players (AV-IN).....	58
HDMI source.....	58
TV tuner .....	58

## **Setup 59**

Monitor Screen Setup .....	59
System Setup .....	59
User Interface Setup.....	59
Special Setup .....	61
Display Setup.....	61
AV Setup .....	63

## **Controlling Audio 65**

3-way speaker system setup .....	65
Speaker / X'over setup.....	66
Controlling General Audio.....	68
Equalizer Control .....	68
Volume Offset .....	69
Zone Control .....	70
Sound Effect .....	71
Listening Position / DTA.....	72
Audio Setup memory .....	73

## **Remote control 74**

Battery Installation.....	74
Functions of the Remote control Buttons.....	74

## **Connection/Installation 77**

Before Installation .....	77
Installing the unit .....	78

## **Troubleshooting 87**

Problems and Solutions .....	87
Error Messages .....	88

## **Appendix 89**

Playable Media and Files.....	89
Specifications.....	90
About this Unit.....	93

## Before Use

### Precautions

#### ⚠ WARNINGS

#### 📖 To prevent injury or fire, take the following precautions:

- To prevent a short circuit, never put or leave any metallic objects (such as coins or metallic tools) inside the unit.
- Do not watch or fix your eyes on the unit's display when you are driving for any extended period.
- If you experience problems during installation, consult your KENWOOD dealer.

#### 📖 Precautions on using this unit

- When you purchase optional accessories, check with your KENWOOD dealer to make sure that they work with your model and in your area.
- You can select a language to display menus, audio file tags, etc. See **User Interface Setup (P.59)**.
- The Radio Data System or Radio Broadcast Data System feature won't work in areas where the service is not supported by any broadcasting station.

#### 📖 Protecting the monitor

- To protect the monitor from damage, do not operate the monitor using a ball point pen or similar tool with a sharp tip.

#### 📖 Cleaning the unit

- If the faceplate of this unit is stained, wipe it with a dry soft cloth such as a silicon cloth. If the faceplate is stained badly, wipe it with a cloth moistened with neutral cleaner, then wipe it again with a clean soft dry cloth.

#### NOTE

- Applying spray cleaner directly to the unit may damage its mechanical parts. Wiping the faceplate with a hard cloth or using a volatile liquid such as thinner or alcohol may scratch the surface or erase the screened print.

#### 📖 Acquiring GPS signal

The first time you turn on this unit, you must wait while the system acquires satellite signals for the first time. This process could take up to several minutes. Make sure your vehicle is outdoors in an open area away from tall buildings and trees for fastest acquisition.

After the system acquires satellites for the first time, it will acquire satellites quickly each time thereafter.

#### 📖 About GLONASS

This unit uses Global Navigation Satellite System (GLONASS) in addition to GPS.

Combining GPS and GLONASS can refine positioning accuracy than using GPS only.

#### 📖 Caution for Smartphone Users

Simultaneously running multiple applications on your smartphone while screen sharing places heavy demand on the microprocessor of the phone, potentially affecting communication and performance.

For best results while pairing with your Kenwood receiver, please be sure to close any unused applications.

### How to read this manual

- The screens and panels shown in this manual are examples used to provide a clear explanation of operations. For this reason, they may be different from the actual screens or panels, or some display patterns may be different from the actual ones.
- **Display language:** English is used for the purpose of explanation. You can select a display language from the **SETUP** menu. See **User Interface Setup (P.59)**.

# Basic Operations

## Functions of the Buttons on the Front Panel

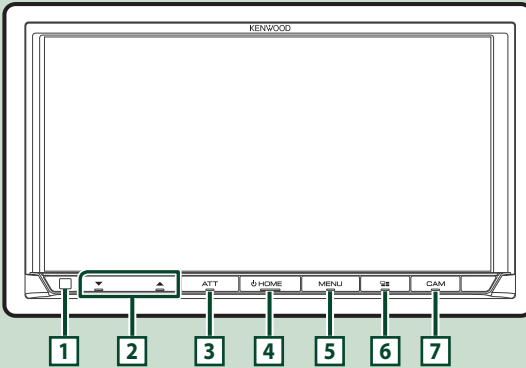

### NOTE

- The panels shown in this manual are examples used to provide a clear explanation of operations. For this reason, they may be different from the actual panels.

Number	Name	Motion
1	Remote Sensor	<ul style="list-style-type: none"> <li>Receives the remote control signal.</li> </ul>
2	▼, ▲ (Volume)	<ul style="list-style-type: none"> <li>Adjusts the volume.</li> <li>The volume will go up to 15 when you keep pressing ▲. (P.10)</li> </ul>
3	ATT	<ul style="list-style-type: none"> <li>Switches attenuation of the volume on/off.</li> </ul>
4	HOME	<ul style="list-style-type: none"> <li>Displays the HOME screen (P.12).</li> <li>Pressing for 1 second turns the power off.</li> <li>When the power is off, turns the power on.</li> </ul>
5	MENU	<ul style="list-style-type: none"> <li>Displays the popup menu screen.</li> <li>Pressing and holding turns the screen off.</li> </ul>
6		<ul style="list-style-type: none"> <li>Displays the APP (Apple CarPlay/Android Auto/Wireless Mirroring) screen.</li> <li>Pressing and holding displays the Voice Recognition screen (P.51).</li> <li>When neither Apple CarPlay, Android Auto, nor a Bluetooth Hands-Free phone is connected, pressing and holding displays Bluetooth pairing waiting dialog. (P.44)</li> </ul>
7	CAM	<ul style="list-style-type: none"> <li>Switches view camera display on/off. (P.55)</li> <li>The camera whose view is displayed first changes according to the "Camera Setup" setting and the shift lever position in the shift gate. The camera whose view was displayed last is kept and the same camera view will be displayed the next time. If its assignment setting is changed, the rear camera view is displayed.</li> </ul>

## Turning on the Unit

The method of turning on is different depending on the model.

- 1 Press the **HOME** button.

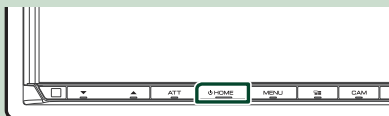

► The unit is turned on.

### ● To turn off the unit:

- 1 Press the **HOME** button for 1 second.

#### NOTE

- If it is your first time to turn the unit on after installation, it will be necessary to perform Initial SETUP (P.8).

## Initial Settings

### Initial SETUP

Perform this setup when you use this unit first time.

- 1 Set each item as follows.

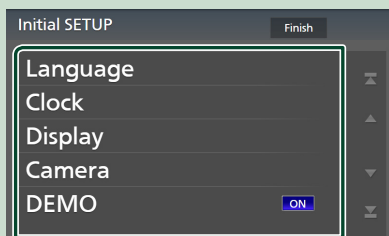

#### ■ Language

Select the language used for the control screen and setting items. Default is "British English(en)".

- ① Touch **Language**.
- ② Touch **Language Select**.
- ③ Select the desired language.
- ④ Touch **↶**.

For details, see **User Interface Setup (P.59)**.

#### ■ Clock

Sets the synchronization of the clock and adjusts it.

For detailed operation, see **Calendar/clock settings (P.10)**.

#### ■ Display

Set the key illumination color.

If it is hard to see the image on the screen even, adjust the viewing angle.

- ① Touch **Display**.
- ② Touch **Key Colour**.
- ③ Select the desired color.
- ④ Touch **↶**.
- ⑤ Touch **Viewing Angle**.
- ⑥ Select a viewing angle.
- ⑦ Touch **↶**.

For details, see **Viewing Angle (P.11)**.

For details, see **Display Setup (P.61)**.

#### ■ Camera

Set the parameters for the camera.

- ① Touch **Camera**.
- ② Set each item and touch **↶**.

For details, see **Camera Setup (P.55)**.

#### ■ DEMO

Set the demonstration mode. Default is "ON".

- 2 Touch **Finish**.

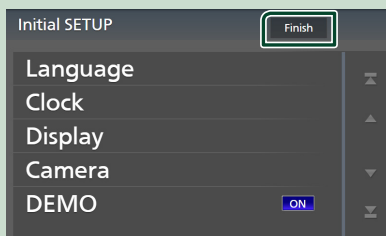

#### NOTE

- These settings can be made from the SETUP menu. See **Setup (P.59)**.



## Security Code Setup

You can set up a security code to protect your receiver system against theft.

When the Security Code function is activated, the code cannot be changed and the function cannot be released. Note the Security Code can be set as the 4 to 8 digit number of your choice.

### Preparation

- Set **DEMO** to **OFF** in the Special screen (P.61).

#### 1 Press the **MENU** button.

- Popup menu appears.

#### 2 Touch **SETUP**.



- SETUP Menu screen appears.

#### 3 Touch **Security**.



- Security screen appears.

#### 4 Touch **Security Code Set** on the Security screen.

- Security Code Set screen appears.

#### 5 Enter a security code with 4 to 8 digit number and touch **Enter**.

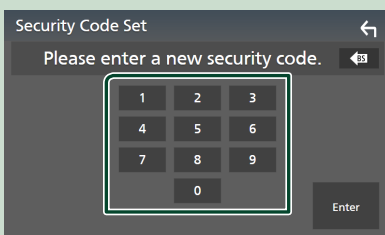

#### 6 Enter the same code again and touch **Enter**.

- Now, your security code is registered.

### NOTE

- Touch **BS** to delete the last entry.
- If you enter a different security code, the screen returns to step 5 (for the first code entry).
- If you have disconnected the Receiver from battery, enter the correct security code as that you have entered in step 5 and touch **Enter**. You can use your receiver.

### To change the security code:

#### 1 Touch **Security Code Change** on the Security screen.

- Security Code Set screen appears.

#### 2 Enter the current registered security code and touch **Enter**.

#### 3 Enter a new security code with 4 to 8 digit number and touch **Enter**.

#### 4 Enter the same code again and touch **Enter**.

- The new security code is registered.

### To clear the security code:

#### 1 Touch **Security Code Cancellation** on the Security screen.

- Security Code Set screen appears.

#### 2 Enter the current registered security code and touch **Enter**.

- The security code is cleared.

## Calendar/clock settings

**1** Press the **MENU** button.

➤ Popup menu appears.

**2** Touch **SETUP**.



➤ SETUP Menu screen appears.

**3** Touch **User Interface**.

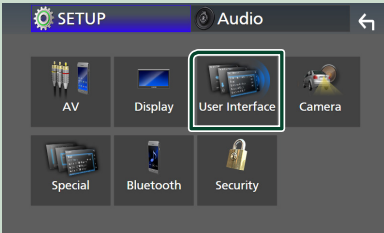

➤ User Interface screen appears.

**4** Set each item as follows.

Scroll the page to show hidden items.

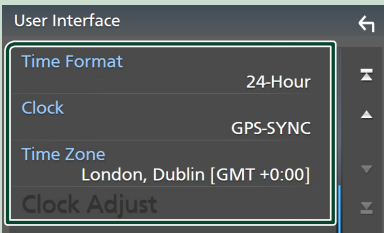

■ **Time Format**

Select the time display format.

**12-Hour / 24-Hour** (Default)

■ **Clock**

**GPS-SYNC** (Default): Synchronizes the clock time with the GPS.

**Manual**: Set the clock manually.

■ **Time Zone**

Select the time zone.

■ **Clock Adjust**

If you select **Manual** for Clock, adjust the date and time manually. **(P.60)**

### NOTE

- Please set the date and time. If they are not set, some functions may not work.

## Adjusting the volume

You can adjust the volume (0 to 40).

Press ▲ to increase, and press ▼ to decrease.

Holding ▲ increases the volume continuously to level 15.

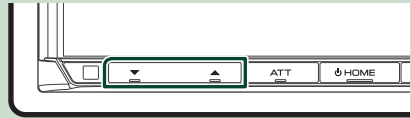

## Viewing Angle

You can adjust the viewing angle when the image on the screen is difficult to see evenly. The smaller the (negative) value, the more whitish the image on the screen looks.

### 1 Press the **MENU** button.

► Popup menu appears.

### 2 Touch **SETUP**.

### 3 Touch **Display**.

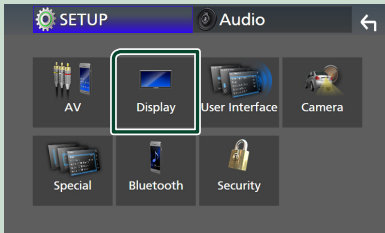

► Display screen appears.

### 4 Touch **Viewing Angle**.

### 5 Select an angle you want to set up.

Default is "0". (P.61)

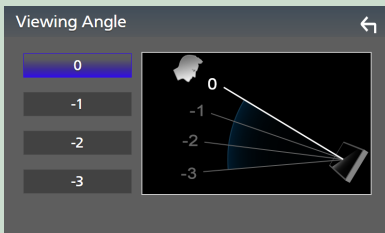

## Touch screen operations

To perform operations on the screen, you need to touch, touch and hold, flick or swipe to select an item, display a setting menu screen or change pages.

### ● Touch

Touch the screen gently to select an item on the screen.

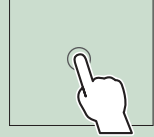

### ● Touch and hold

Touch the screen and keep your finger in place until the display changes or a message is displayed.

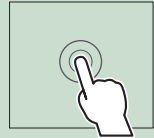

### ● Flick

Slide your finger quickly to the left or right on the screen to change the page. You can scroll a list screen by flicking up/down on the screen.



### ● Swipe

Slide your finger up or down on the screen to scroll the screen.

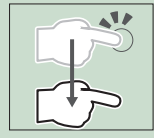

## HOME screen descriptions

Most functions can be performed from the HOME screen.



- 1 • Widget (P.17)
  - You can change the widget by flicking left or right on the widget area.
  - Touch the widget to display the detailed screen.
- 2 • Displays the source selection screen. (P.13)
- 3 • Short-cut playback source icons (P.14)

## Display the HOME screen

- 1 Press the **HOME** button.



➤ HOME screen appears.

## Popup menu

- 1 Press the **MENU** button.
  - Popup menu appears.
- 2 Touch to display the popup menu.



The contents of the menu are as follows.

	• Displays the Screen Adjustment screen. (P.59)
	• Turns the display off. (P.13)
	• Displays the view camera screen. (P.55)
	• Displays the SETUP Menu screen. (P.59)
	• Displays the Audio screen. (P.65)
	• Displays the control screen of current source. Icon feature differs depending on the source. This icon is for USB source.
	• Close the popup menu.
	• Displays the Android Auto device list. This icon appears only when Android Auto is connected and two or more devices can be used as Android Auto source.
1	• Short-cut source icons: The source changes to the one you have set with a short-cut. For the short-cut setting, refer to <b>Customize Short-cut source icons on HOME screen</b> (P.14).

## Turn off the screen

**1** Select **Display OFF** on the popup menu.



### NOTE

- Touch the display to turn on the screen.
- To display the clock while the screen is off, it is necessary to set "OSD Clock" to "ON". **(P.61)**

## Source selection screen description

You can display icons of all playback sources and options on the source selection screen.

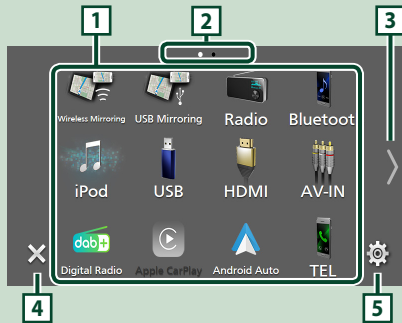













- |          |  |
|----------|--|
| <b>1</b> | • Changes playback source. For playback sources, see <b>Select the playback source (P.13)</b> .            |
| <b>2</b> | • Page indication  |
| <b>3</b> | • Changes pages. (Touch <b>◀/▶</b> )<br>You can also change pages by flicking left or right on the screen. |
| <b>4</b> | • Returns to the previous screen.  |
| <b>5</b> | • Displays the SETUP Menu screen. <b>(P.59)</b>  |

## Select the playback source

**1** Press the **HOME** button.  
➤ HOME screen appears.

**2** Touch .

From the screen, you can select the following sources and functions.

	• Switches to the Apple CarPlay screen from the connected iPhone. <b>(P.23)</b>
	• Switches to the Android Auto screen from the connected Android smartphone. <b>(P.26)</b>
	• Displays the Hands Free screen. <b>(P.49)</b> When neither Apple CarPlay, Android Auto, nor a Bluetooth Hands-Free phone is connected, displays Bluetooth pairing waiting dialog.*1 <b>(P.44)</b>
	• Switches to the Radio broadcast. <b>(P.35)</b>
	• Switches to the Digital Radio broadcast. <b>(P.39)</b>
	• Plays a Bluetooth audio player. <b>(P.47)</b>
	• Plays an iPod/iPhone. <b>(P.32)</b>
	• Plays files on a USB device. <b>(P.29)</b>
	• Plays a device connected to the HDMI input terminal. <b>(P.58)</b>
	• Switches to an external component connected to the AV-IN input terminal.*2 <b>(P.58)</b>
	• Switches to the Wireless Mirroring screen from the connected Android smartphone.*3 <b>(P.21)</b>
	• Switches to the USB Mirroring screen from the connected iPhone/Android smartphone. <b>(P.21)</b>
	• Displays the Audio screen. <b>(P.65)</b>
	• Puts the unit in standby. <b>(P.14)</b>

\*1 When connecting as Apple CarPlay or Android Auto, it works as a phone provided in Apple CarPlay or Android Auto. If Apple CarPlay or Android Auto are connected during talking by the Bluetooth device, the current call will be continued.

\*2 CA-C3AV (optional accessory) is connected to the AV-IN input terminal for visual. **(P.83)**

\*3 DMX8020DABS only

### To select the playback source on the HOME screen



The 4 items displayed on the source selection screen with large icons are shown on the HOME screen.

You can change the items displayed on this area by customizing the source selection screen. (P.14)

### To select the playback source on the source control screen

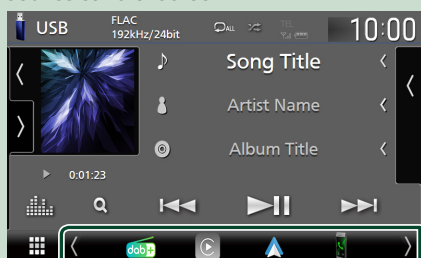

Display source selection icons by touching or or flicking left or right on the source control screen, then select a playback source.

### Put the unit in standby

- 1 Press the **HOME** button.  
➤ HOME screen appears.
- 2 Touch .
- 3 Touch **STANDBY**.

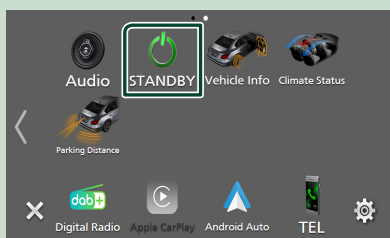

### Customize Short-cut source icons on HOME screen

You can arrange the positions of the source icons as you like.

- 1 Press the **HOME** button.  
➤ HOME screen appears.
- 2 Touch .
- 3 Touch and hold the icon which you want to move in the customizing mode.
- 4 Drag the icon to the desired position.

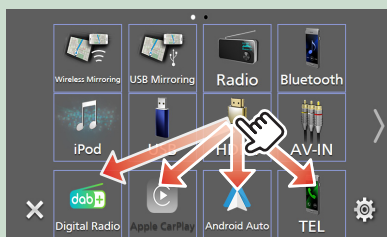

### Changes the page

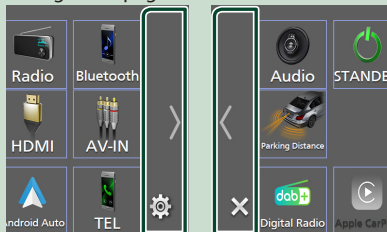

## Source control screen descriptions

There are some functions which can be performed from most screens.

### Indicators

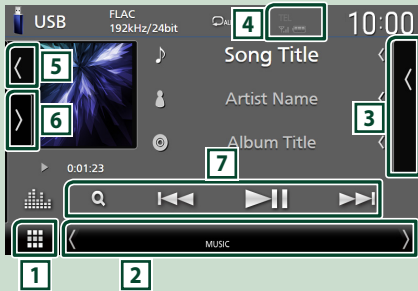



### Short-cut source icons



#### 1 All sources icon

Displays the source selection screen. (P.13)

#### 2 Secondary screen

-   : The Secondary screen changes to another one every time you touch it. You can also change the Secondary screen by flicking left or right on the screen.
- Indicators: Displays the current source condition and so on.
  - **ATT**: The attenuator is active.
  - **DUAL**: The dual zone function is active.
  - **MUTE**: The mute function is active.
  - **LOUD**: The loudness control function is active.
- Short-cut source icons: The source changes to the one you have set with a short-cut. For the short-cut setting, refer to **Customize Short-cut source icons on HOME screen (P.14)**.

#### 3 Content list

Displays the track/file/station/channel list.

#### 4

- Connected Bluetooth device information.

#### 5 Artwork & information

You can select whether to display an artwork and song information or only song information in more detail.

Touching the artwork area switches to the VU meter. (The USB, iPod, Bluetooth audio sources only)

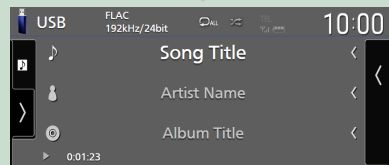
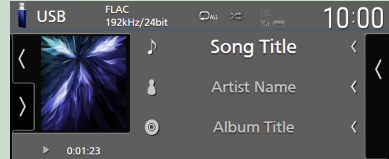

Change the text size of song information when the "Small Audio Text" is set to "ON"/"OFF" in the User Interface screen (P.60).

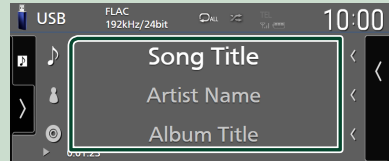
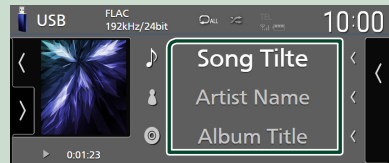

#### 6 Function panel

Touch the left side of the screen to display the function panel. Touch again to close the panel.

#### 7 Operation keys

You can operate the current source with these operation keys. The available functions are different depending on the source type.

## List screen

There are some common function keys in the list screens of most sources.  
See (P.31, 34, 48).

### Display the list screen

#### For USB/iPod:

- 1 Touch **Q** or the item listed on the information area in the source control screen.
  - The list screen appears.

#### For Bluetooth audio:

- 1 Touch **Q** .
  - The list screen appears.

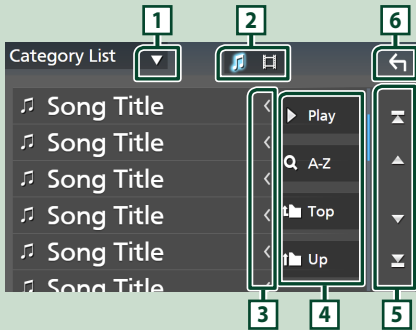

- 1 Displays the list type selection window.

- 2 Displays a music/movie file list.

- 3 **Text scroll**  
Scrolls the displayed text.

- 4 **Play etc.**

Keys with various functions are displayed here.

- **Play** : Plays all tracks in the folder containing the current track.
- **Q A-Z** : Jumps to the letter you entered (alphabetical search).
- **Top Up** : Moves to the upper hierarchy level.

- 5 **Page scroll**

You can change pages to display more items by touching .

- : Displays the top or bottom page.

- 6 **Return**

Returns to the previous screen.

#### NOTE

- Depending on the current source or mode, some function key may not appear.



# Widget

## Widget

- 1 Press the **HOME** button.
- 2 You can change the widget by flicking left or right on the widget area.



### Widget list

- Multi Widget \*1
- Clock Widget
- Tire Pressure Widget \*2
- Climate Widget \*2
- Photo Frame Widget

\*1 Up to 3 pages can be set to the multi widget screen.

\*2 This can be selected when a commercial adaptor is connected.

## Multi Widget

You can place a widget on each of the following areas. Up to 4 widgets can be placed per a multi widget screen.

- 1 Press the **HOME** button.
- 2 Flick the widget area to the left/right to display the multi widget.



1 Widget (L)

2 Widget (M)

3 Widget (S1)

4 Widget (S2)

### Replace the widget

#### ● To move the widget

- 1 Touch and hold the widget.
  - Widget customize mode is activated.
- 2 Drag the widget to the desired position.

#### ● To delete the widget

- 1 Touch and hold the widget.
  - Widget customize mode is activated.
- 2 Touch **×** on the right top corner of the widget.
  - The selected widget is deleted.

## Widget

### ● To replace the widget

- 1 Touch  on the multi widget screen.

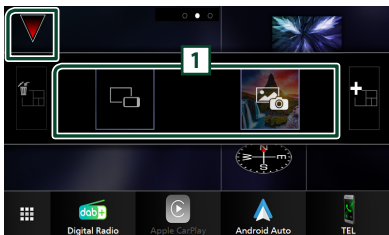

➤ Widget list popup appears.

### **1** Widget icon

The widgets which can be placed to the multi widget screen are listed.

- 2 Flick the widget list popup to the left/right to select the widget to replace.
- 3 Touch and hold the new widget.  
➤ Widget customize mode is activated.
- 4 Drag the widget from the widget list popup to the desired widget area.

You can set up following items.

- Clock Widget
- Current source information \*1
- Visualizer Widget
- Mirroring Widget \*2 \*3
- Photo Frame Widget
- Climate Widget \*4
- Tire Pressure Widget \*4



\*1 You cannot display the screen of Wireless Mirroring (DMX8020DABS only)/USB Mirroring on this widget. To display the screen of the source, select the Mirroring Widget.

\*2 This can be selected when using Wireless Mirroring (DMX8020DABS only)/USB Mirroring.

\*3 You cannot play the video file on the USB when using Wireless Mirroring (DMX8020DABS only)/USB Mirroring.

\*4 This can be selected when a commercial adaptor is connected.

#### NOTE

-  and the widget list popup disappear when no operation is done for 5 seconds.
- When the screen is switched from another widget to multi widget screen,  appears again.

### Add a new multi widget

You can add pages to the multi widget screen.

- 1 Touch  on the multi widget screen.

➤ Widget list popup appears.



Displays confirmation message to delete the current page from the multi widget screen. For details, see **To delete the multi widget (P.18)**.



Adds a page to the multi widget screen.

- 2 Touch  on the widget list popup.

➤ A new page is added.

#### NOTE

- You can add up to pages to the 2 multi widget screen. If you have already added 2 pages, you cannot select .
- The widget tray is displayed on the new page until you place a widget to.

### To delete the multi widget

- 1 Touch  on the widget list popup.

➤ Confirmation message appears.

- 2 Touch **YES**.

➤ Current page is deleted.

#### NOTE

- You cannot delete the first page of the multi widget screen.

## Photo Frame Widget

You can display a slideshow of the image files stored in the USB memory on the Home screen.

### Preparation

- Select "ON" for Photo Frame Widget. See **Widget SETUP (P.19)**.

#### ● Acceptable Picture files

	Max. Picture size
JPEG (.jpg, .jpeg) *1	5,000 × 5,000
PNG (.png)	1,000 × 1,000
BMP (.bmp)	1,000 × 1,000

- This unit can only play back files which are less than 50 MB.
- The maximum number of files per device is 500.
- Picture files may not be played depending on their condition.

\*1 A progressive format is not supported.

### Photo Frame

- 1 Press the **HOME** button.
- 2 Flick the widget area to the left/right to display the photo frame widget.

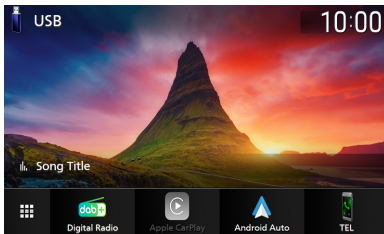

- Scroll the screen to display the hidden part.

## Widget SETUP

Set up the widgets on the Home screen.

- 1 Press the **MENU** button.  
➤ Popup menu appears.
- 2 Touch **SETUP**.  
➤ SETUP screen appears.
- 3 Touch **User Interface**.



- User Interface screen appears.

- 4 Touch **Widget SETUP** in the User Interface screen.
- 5 Set each item as follows.
  - **Photo Frame Widget**  
Determine whether to use the photo frame widget.  
"ON" (Default)/"OFF"
  - **Photo Frame SETUP**  
Make settings related to display of the photo frame widget.
- 6 Touch .

## Widget

### To Photo Frame Setup

Make settings related to display of the photo frame widget.

**1** Touch **Photo Frame SETUP** on the **Widget SETUP** screen.

**2** Set each item as follows.

■ **Sort Order**

Specify a file sorting criterion.

"By Name(Ascending)"/

"By Name(Descending)"/

"By Date(Newest First)" (Default)/

"By Date(Oldest First)"

■ **Slide Show Interval**

Specify the slideshow interval.

"5" to "30" seconds.

Default is "5" seconds.

■ **Photo Frame is** ●●●●●

Display help topics about the photo frame.

**3** Touch  .

# APPS

## Wireless Mirroring Operation (DMX8020DABS)

You can display the same screen of the Android smartphone on the monitor of the unit using the Wireless Mirroring function of the Android smartphone.

### Preparation

- You can use the Wireless Mirroring function with Android smartphones compatible with this function.
- This function may be called Wireless Display, Screen Mirroring, AllShare Cast, etc., depending on the manufacturer.
- The settings on the Android smartphone differ depending on the device type. For details, refer to the instruction manual supplied with your Android smartphone.
- If your Android smartphone is locked, Mirroring screen may not appear.
- If the Android smartphone is not ready for UIBC, you cannot perform touch operation..

- 1 Press the **HOME** button.
- 2 Touch .
- 3 Touch **Wireless Mirroring . (P.13)**
  - The App screen is displayed.
- 4 Operate your Android smartphone to activate the Wireless Mirroring function, then connect to this unit.
- 5 Select ("DMX8020DABS") as the network to use.
  - When the connection is established, then the same screen displayed on the Android smartphone is displayed.

### NOTE

- Apps is discontinued when the power is turned ON/OFF or you leave the vehicle. To restart Apps, operate the Android smartphone..
- When the Apps source is displayed, you cannot register or reconnect a Bluetooth device. Switch the Apps source to another source, and then operate the Bluetooth device.

## USB Mirroring Operation

With Mirroring for KENWOOD application installed on your smartphone, you can display the screen of your smartphone on the screen of this unit and listen to either the audio of your smartphone or current source of this unit. You may access your smartphone from this unit.

You can use the USB Mirroring function with your smartphone compatible with this function.

### Compatible devices

- Android smartphone
  - Bluetooth support
  - Android version 5.0 or later
  - Linux Kernel version 3.5 or later
- iPhone
  - Bluetooth support
  - iOS version 11 or later

### Preparation

- Install the latest version of the Mirroring for KENWOOD application and activate the application on your smartphone.
    - Android smartphone:** Search for "Mirroring for KENWOOD" in Google Play to find and install the most recent version.
    - iPhone:** Search for "Mirroring for KENWOOD" in Apple App Store to find and install the most recent version.
- Mirroring for KENWOOD application is a free application. You can check "how to" tutorial in Mirroring for KENWOOD application.

### Connect the device

Screen is mirrored through USB (Black) terminal connection while audio is shared via Bluetooth connection between this unit and your smartphone.

**For Android smartphones:**

**1** Pair your Android smartphone with this unit via Bluetooth. See *Register the Bluetooth device (P.44)*.

Select A2DP/SPP **Audio/App**.

**2** Press the **HOME** button.

**3** Touch .

**4** Touch **USB Mirroring**. (P.13)

**5** Connect your Android smartphone via the **USB (Black) terminal**. (P.85)

When you use Mirroring for KENWOOD application for the first time, the terms of service are displayed. It is necessary to agree to the terms of service to use this function.

**For iPhone:**

**1** Pair your iPhone with this unit via Bluetooth. See *Register the Bluetooth device (P.44)*.

Select A2DP/SPP **Audio/App**.

**2** Touch “Mirroring for KENWOOD” and start broadcast.

**3** Press the **HOME** button.

**4** Touch .

**5** Touch **USB Mirroring**. (P.13)

**6** Connect your iPhone using KCA-iP103 via the **USB (Black) terminal**. (P.84)

**7** Operate your iPhone to complete followings.





- Launch “Settings”, then touch “Control Center” and then “Customize Controls”.
- Touch “Screen Recording” and add to “INCLUDE” list.
- Launch “Control Center” of your iPhone, then touch and hold Screen Recording icon.

**NOTE**

- USB (Gray) terminal does not support USB Mirroring. (DMX8020DABS only)
- You cannot use the Bluetooth and iPod sources at the same time with Mirroring for KENWOOD application.
- OSD clock is not shown on the mirroring screen of this unit regardless of the setting made for **OSD Clock (P.61)**.
- Depending on the connected Android smartphone, you may need to enable virtual keyboard setting on your smartphone to display software keyboard on the screen of this unit and on your smartphone.
- Mirroring for KENWOOD application is discontinued by the following operations if you use the application with an iPhone:
  - Receiving an incoming call
  - iPhone’s screen recording function is stopped
  - iPhone screen is turned off
 To resume the mirroring operation, disconnect the iPhone from the USB Audio cable, and try connecting it again.
- The audio may be of poor quality, interrupted or skipped, depending on several conditions such as network condition, the application and etc.
- If you perform pairing with another device during mirroring, mirroring (audio and/or video) will be disturbed or paused.
- Some applications may not support audio sharing.
- Some operations may not work depending on the compatibility between this unit, Mirroring for KENWOOD application and your smartphone.

## Operation keys on the mirroring screen

On the USB mirroring screen, the following virtual hard keys are available. The keys are hidden when no operation is done for about 5 seconds. You can display back them anytime by touching the screen.

- : Changes the virtual hard keys position shown on the screen of this unit.
- : Returns to home page.
- : Closes the virtual hard keys.
- : Shows the recent applications (Android only).
- : Returns to the previous page (Android only).

### NOTE

- These keys differ depending on the connected device and may differ from the function operated from the device.
- These keys can be displayed even if there is no hard key on the connected device.

## Disconnect mirroring

You can disconnect mirroring by disconnecting your smartphone from the USB (Black) terminal from the rear panel.

### NOTE

- Once you disconnect from mirroring operations, stop broadcast on iPhone's screen recording function. Otherwise "iPod" source and "Bluetooth" source may not work correctly.

## Apple CarPlay Operation

Apple CarPlay is a smarter, safer way to use your iPhone in the car. Apple CarPlay takes the things you want to do with iPhone while driving and displays them on the screen of the product. You can get directions, make calls, send and receive messages, and listen to the music from iPhone while driving. You can also use Siri voice control to make it easier to operate iPhone.

For details about Apple CarPlay, visit <https://www.apple.com/ios/carplay/>.

### Compatible iPhone devices

You can use Apple CarPlay with the following iPhone models.

- iPhone XS Max
- iPhone XS
- iPhone XR
- iPhone X
- iPhone 8 Plus
- iPhone 8
- iPhone 7 Plus
- iPhone 7
- iPhone SE
- iPhone 6s Plus
- iPhone 6s

## Connecting an iPhone

### Preparation

- To register an iPhone by the connection via the USB (Black) terminal
  - Connect an iPhone via the USB (Black) terminal and operate the iPhone according to the confirmation messages displayed on the iPhone. The iPhone is registered in **Apple CarPlay Device List**. Removing the iPhone from the USB (Black) terminal and selecting the registered iPhone from **Apple CarPlay Device List**, the iPhone will be connected wirelessly.
- To register an iPhone by the connection via Bluetooth
  - Touching  on the **Apple CarPlay Device List** screen (P.24), displays Bluetooth pairing waiting dialog. Referring to **Register the Bluetooth device (P.44)** and registering the iPhone, the iPhone will be connected wirelessly.

**Wired connection**

**1 Connect your iPhone using KCA-iP103 via the USB (Black) terminal. (P.84)**

When an iPhone compatible with Apple CarPlay is connected to the USB (Black) terminal, the Bluetooth Hands-Free phone currently connected is disconnected. If the Bluetooth Hands-Free phone is being used, disconnection will occur after ending the call.

**2 Unlock your iPhone.**

**Wireless connection (DMX8020DABS)**

You can select the iPhone registered as the Bluetooth device from **Apple CarPlay Device List** and use it as the Apple CarPlay device.

**1 Press the HOME button.**

**2 Touch .**

**3 Touch Apple CarPlay. (P.13)**

**NOTE**

- Turn on the Bluetooth function and Wi-Fi function of an iPhone.
- If two or more iPhones have been registered, select the iPhone to be used as the **Apple CarPlay** source. (P.24)
- You can also select the iPhone registered in **Apple CarPlay Device List** (P.24) even when the **Apple CarPlay** icon is not activated on the source selection screen.
- It is necessary to connect the GPS antenna and the speed pulse input in order to use a wireless Apple CarPlay.
- When the Wi-Fi connection becomes unavailable, the HOME screen is displayed.
- You cannot use Apple CarPlay if the iPhone's screen recording function is enabled.

**To switch the Current Screen to the Apple CarPlay Screen When Connecting Your iPhone**

- Touch **Apple CarPlay** icon on the source selection screen. (P.13)
- Touch the following connection message if the message appears.



**NOTE**

- The connection message appears when;
  - The iPhone you used previously is connected again.
  - The screen other than HOME and the source selection screen is displayed.
- The connection message is displayed for about 5 seconds.

**Select an Apple CarPlay device (DMX8020DABS)**

If two or more iPhones compatible with Apple CarPlay have been registered, select the iPhone to be used as the Apple CarPlay source.

**1 Press the MENU button.**

➤ Pop-up menu appears.

**2 Touch SETUP.**

➤ SETUP screen appears.

**3 Touch AV.**

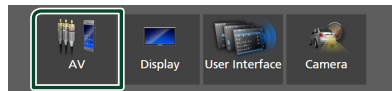



**4 Touch Apple CarPlay Device List.**

**5 Select a device.**

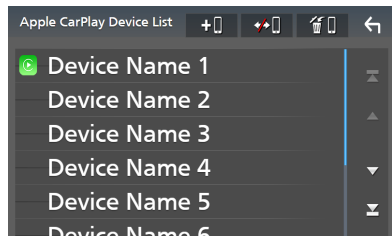
The Apple CarPlay device connected via the USB and the registered Apple CarPlay devices ready for wireless connection are displayed.



-  : Displays a Bluetooth pairing waiting dialog. For details, see **Register the Bluetooth device** (P.44).
-  : Displays confirmation message to disconnect the device.
-  : Displays Device Remove screen. (P.25)



## To delete the registered Apple CarPlay device

1 Touch .

2 Touch the device name to check.

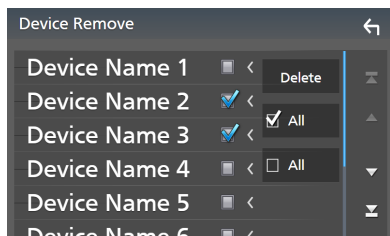

■  **ALL**

Selects all Apple CarPlay devices.

■  **ALL**

Clears all check marks.

3 Touch **Delete**.

► Confirmation message appears.

4 Touch **Yes**.

► All the selected device(s) is deleted.

### NOTE

- This operation also deletes the same device(s) from the Bluetooth device list screen. (P.46)

## Operation keys and available Apps on the home screen of Apple CarPlay

You can use the Apps of the connected iPhone. The items displayed and the language used on the screen differ among the connected devices.

To enter the Apple CarPlay mode, touch **Apple CarPlay** icon on the source selection screen. (P.13)

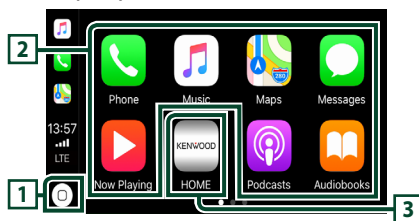

1 

- Displays the home screen of Apple CarPlay.
- Touch and hold to activate Siri.

2 **Application keys**

Starts the application.

3 **HOME**

Exits the Apple CarPlay screen and displays the Home screen.

\* The icon design may change depending on the iOS version.

## To exit the Apple CarPlay screen

1 Press the **HOME** button.

## Use Siri

You can activate Siri.

1 Press the  button for 1 second.

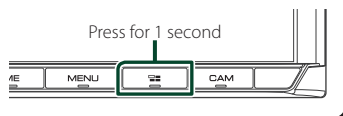

2 Talk to Siri.

## To deactivate

1 Press the  button.

## Switch to the Apple CarPlay screen while listening to another source

- 1 Press the  button.



### NOTE

- When listening to another source with the Apple CarPlay screen displayed, playing music in the Apple CarPlay mode will switch the current source to the Apple CarPlay source.

## Android Auto™ Operation

Android Auto enables you to use the functions of your Android smartphone convenient for driving. You can easily access route guidance, make calls, listen to music, and access convenient functions on the Android smartphone while driving.

For details about Android Auto, visit <https://www.android.com/auto/> and <https://support.google.com/androidauto>.

### Compatible Android smartphones

You can use Android Auto with Android smartphones of Android version 5.0 or later. For Wi-Fi connection, Android 8.0 or later. (DMX8020DABS)

### NOTE

- Android Auto may not be available on all devices and may not be available in all countries or regions.

### ● About the placement of smartphone

Install the smartphone connected as Android Auto device in the place where it can receive the GPS signals.

When using the Google Assistant, install the smartphone in the place where the smartphone easily catch a voice by the microphone.

### NOTE

- Do not put the smartphone in a spot exposed to direct sunlight or near an air blowing out port of an air conditioner. The placement of the smartphone in such places can lead to malfunction or damage of your smartphone.
- Do not leave the smartphone in the vehicle.

## Connect Android smartphone

### Wired connection

#### 1 Connect an Android smartphone via the USB terminal. (P.85)

To use the hands-free function, connect the Android smartphone via Bluetooth.

When an Android smartphone compatible with Android Auto is connected to the USB terminal, the device is connected via Bluetooth automatically, and the Bluetooth Hands-Free phone currently connected is disconnected.

#### 2 Unlock your Android smartphone.

#### 3 Press the **HOME** button.

#### 4 Touch .

#### 5 Touch **Android Auto**. (P.13)

### Wireless connection (DMX8020DABS)

When the Android smartphone is ready for wireless connection, connecting it via the USB registers Bluetooth and Wi-Fi automatically. Thus, the registered Android smartphone will be able to be connected wirelessly to be used as an Android Auto source.

#### 1 Press the **HOME** button.

#### 2 Touch .

#### 3 Touch **Android Auto**. (P.13)

#### NOTE

- Turn on the Bluetooth function and Wi-Fi function of Android smartphone.
- If two or more Android smartphone have been registered, select the Android smartphone to be used as the Android Auto source. (P.27)
- To change the password for wireless connection manually, refer to **Reset Android Auto Wireless Connection (P.64)**.
- When the Wi-Fi connection becomes unavailable, the HOME screen is displayed.

## Select an Android smartphone (DMX8020DABS)

If two or more Android smartphones have been registered, select the Android smartphones to be used as the Android Auto source.

#### 1 Press the **HOME** button.

#### 2 Touch .

#### 3 Touch **Android Auto**. (P.13)

#### 4 Press the **MENU** button.

#### 5 Touch .

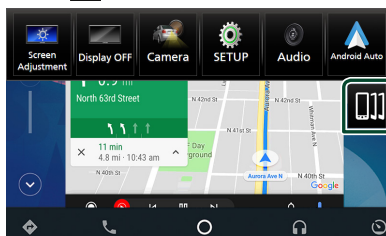

#### 6 Select an Android smartphone.

The registered Android smartphones ready for wireless connection and the Android smartphones connected via the USB are displayed.

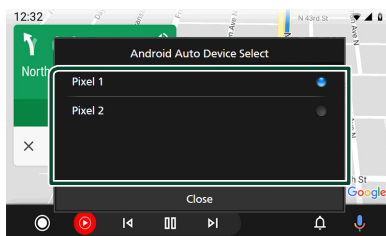

## Operation keys and available Apps on the Android Auto screen

You can perform the operations of the Apps of the connected Android smartphone.

The items displayed on the screen differ among the connected Android smartphone.

To enter the Android Auto mode, touch the **Android Auto** icon on the source selection screen. (P.13)

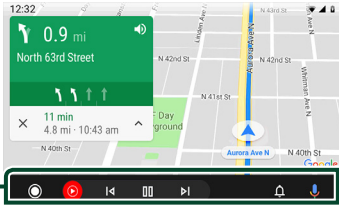

### 1 Application/information keys

Starts the application or displays information.

### To exit the Android Auto screen

- 1 Press the **HOME** button.

## Using voice control

- 1 Press the button for 1 second.

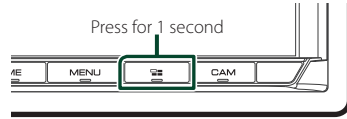

### To cancel

- 1 Press the button.

## Switch to the Android Auto screen while listening to another source

- 1 Press the button.



### NOTE

- When listening to another source with the Android Auto screen displayed, playing music in the Android Auto mode will switch the current source to the Android Auto source.

# USB

## Connecting a USB device

- 1 Connect the USB device with the USB cable. (P.84)

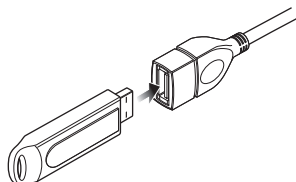

- 2 Press the **HOME** button.
- 3 Touch .
- 4 Touch **USB**. (P.13)

### Disconnect the USB device

- 1 Press the **HOME** button.
- 2 Touch a source other than **USB**.
- 3 Detach the USB device.

### Usable USB device

You can use a mass-storage-class USB device with this unit.

The word "USB device" appearing in this manual indicates a flash memory device.

#### ● About the file system

The file system should be the one of the following.

- FAT16
- FAT32
- exFAT
- NTFS

#### NOTE

- Install the USB device in the place where it will not affect safe driving.
- You cannot connect a USB device via a USB hub and Multi Card Reader.
- Take backups of the audio files used with this unit. The files can be erased depending on the operating conditions of the USB device. We shall have no compensation for any damage arising from any erased data.

## USB Basic Operation

Most functions can be controlled from the source control screen and playback screen.

#### NOTE

- Set the remote controller mode switch to **AUD** mode before starting operation, see **Switch the operation mode (P.74)**.

#### Control screen

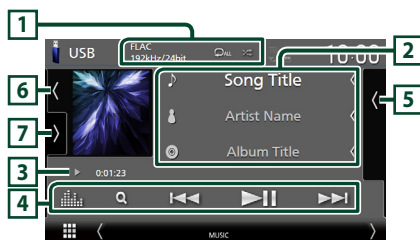



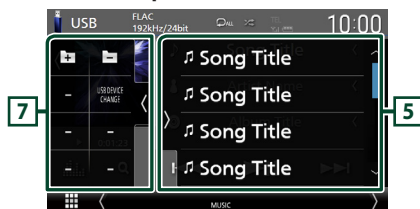

#### Open the drawer

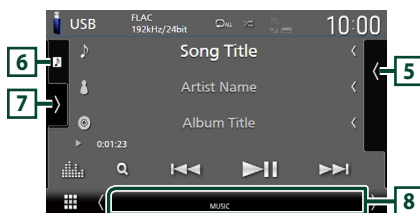



#### Close the drawer



#### 1 CODEC / / /







- When a high-resolution source is played, its format information is displayed.
- : Repeats the current track/folder. Each time you touch the key, repeat modes are switched in the following sequence: File repeat () , Folder repeat () , Repeat all ()

-  : Randomly plays all tracks in the current folder. Each time you touch the key, random modes are switched in the following sequence: File random (  ), Random off (  )

### 2 Track information





- Displays the information on the current file. Only a file name and a folder name are displayed if there is no tag information.
- Change the text size of the information when the "Small Audio Text" is set to "ON"/"OFF" in the User Interface screen (P.60).

### 3 Play mode indicator/Playing time

- , , etc.: Current play mode indicator. Meanings of individual icons are as follows:  (play),  (fast forward),  (fast backward),  (pause).
- For confirmation of current playing position. You can drag the circle left or right to change the playing position. (Video file only)



### 4 Operation keys

-  : Searches track/file. For details on search operation, see **Search Operation (P.31)**.
- ,  : Searches the previous/next track/file. Touch and hold to fast forward or fast backward. (It will be cancelled automatically after about 50 seconds.)
-  : Plays or pauses.
-  : Displays the Graphic Equalizer screen. (P.68)

### 5 Content list



- Touch the right side of the screen to display the Content list. Touch again to close the list.
- Displays the playing list. When you touch a track/file name on the list, playback will start.

### 6 Artwork/VU meter

- Displays/hides artwork area.
- The jacket of the currently playing file is displayed.
- Touch to switch between the artwork and VU meter.

### 7 Function panel

Touch the left side of the screen to display the function panel. Touch again to close the panel.

-   : Searches for the previous/next folder.

#### • USB DEVICE CHANGE :

Switches to another USB device when two USB devices are connected. (DMX8020DABS only)

### 8 Indicator Items

- **VIDEO** : Identifies the video file.
- **MUSIC** : Identifies the music file.

Video screen



#### 9 File search area (Video file only)

Touch to search for the next/previous file.

#### 10 Key display area (Video file only)

Touch to display the control screen.

## Search Operation

You can search music or video files by the following operations.

1 Touch **Q**.

2 Touch **▼**.



3 Select a list type.

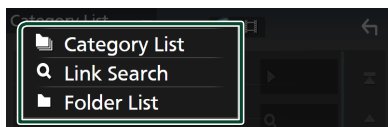



### NOTE

• For operations on the list screen, see *List screen (P.16)*.

## Category search

You can search for a file by selecting a category.

1 Touch **Category List**.

2 Select whether you search audio files  or video files .

3 Touch the desired category.

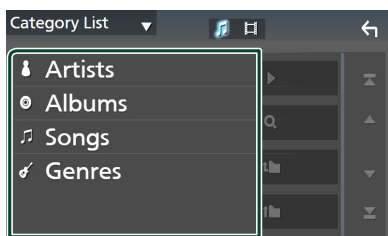

► The list corresponding to your selection appears.

4 Touch to select the desired item in the list. Repeat this step until you find the desired file.

## Link search

You can search for a file of the same artist/album/genre as that in the current track.

1 Touch **Link Search**.

2 Touch the desired tag type. You can select from artists, albums and genres.

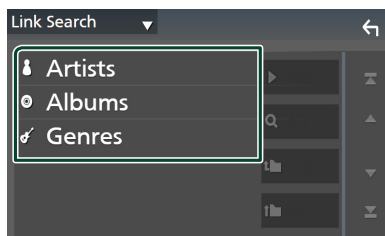

► The list corresponding to your selection appears.

3 Touch the desired item in the content list.

## Folder search

You can search for a file according to hierarchy.

1 Touch **Folder List**.

2 Touch the desired folder.

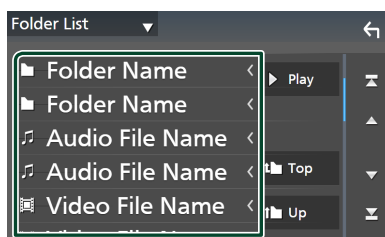

When you touch a folder its contents are displayed.

3 Touch to select your desired item in the list. Repeat this step until you find the desired file.

# iPod/iPhone

## Preparation

### Connectable iPod/iPhone

The following models can be connected to this unit.

Made for

- iPhone XS Max
- iPhone XS
- iPhone XR
- iPhone X
- iPhone 8 Plus
- iPhone 8
- iPhone 7 Plus
- iPhone 7
- iPhone SE
- iPhone 6s Plus
- iPhone 6s
- iPod touch (6th generation)

#### NOTE

- Latest compatible list of iPod/iPhone. For details, see [www.kenwood.com/cs/ce/ipod/](http://www.kenwood.com/cs/ce/ipod/).
- By connecting your iPod/iPhone to this unit with the iPod connection cable KCA-iP103 (optional accessory), you can supply power to your iPod/iPhone as well as charge it while playing music. Note that the power of this unit must be held on.
- If you restart playback after connecting the iPod, the music that has been played by the iPod is played first.

### Connect iPod/iPhone

#### Wired connection

##### Preparation

- Connect an iPod/iPhone with the KCA-iP103 (optional accessory) while Apple CarPlay is not connected.
- With an Apple CarPlay-capable iPhone, turn off Apple CarPlay by operating the iPhone at functional setup before connecting iPhone. For details of the setup method, contact the manufacturer of the terminal.
- Plug the iPod/iPhone into the gray USB terminal with the KCA-iP103 (optional accessory). (DMX8020DABS only)
- Plug the iPod/iPhone into the USB terminal with the KCA-iP103 (optional accessory). (DMX7520DABS only)
- Only one iPod/iPhone can be connected.

**1** Connect the iPod/iPhone using the KCA-iP103. (P.84)

**2** Press the **HOME** button.

**3** Touch .

**4** Touch **iPod**. (P.13)

● **To disconnect the iPod/iPhone connected with the cable:**

**1** Detach the iPod/iPhone.

#### Bluetooth connection

Pair the iPhone through Bluetooth.

##### Preparation

- To connect an iPhone via Bluetooth, register it as a Bluetooth device and do the profile setting for the connection beforehand. See **Register the Bluetooth device (P.44)** and **Connect the Bluetooth device (P.45)**.
- Connect an iPhone via Bluetooth while Apple CarPlay and an iPod/iPhone are not connected via USB.
- With an Apple CarPlay-capable iPhone, turn off Apple CarPlay by operating the iPhone at functional setup before connecting iPhone. For details of the setup method, contact the manufacturer of the terminal.

● **Select the method of making connections for outputting sound from the iPod source**

**1** Press the **MENU** button.

➤ Pop-up menu appears.

**2** Touch **SETUP**.

➤ SETUP screen appears.

**3** Touch **AV**.

➤ AV screen appears.

**4** Touch **iPod Bluetooth Connection**.

**Bluetooth** (Default): Output sound using a Bluetooth device.

**Bluetooth+HDMI**: Output sound using an HDMI device and perform music selection, etc. using a Bluetooth device.



## iPod/iPhone Basic Operation

### NOTE

- Set the remote controller mode switch to AUD mode before starting operation, see **Switch the operation mode (P.74)**.

### Control screen

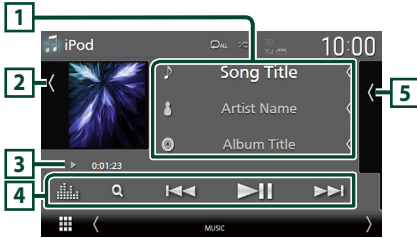

### Open the drawer

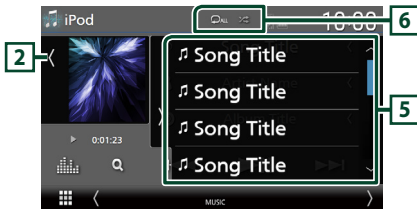

### Close the drawer

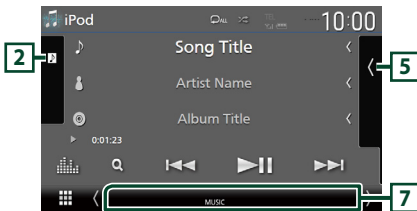

### 1 Track information

- Displays the information on the current file.
- Touch to display the category list screen. See **Category search (P.34)**.
- Change the text size of the information when the "Small Audio Text" is set to "ON"/"OFF" in the User Interface screen **(P.60)**.

### 2 Artwork/VU meter

- Displays/hides artwork area.
- The jacket of the currently being played file is displayed.
- Touch to switch between the artwork and VU meter.

### 3 Play mode indicator/Playing time

- ▶, ▶▶, etc.: Current play mode indicator  
Meanings of individual icons are as follows:  
▶ (play), ▶▶ (fast forward), ◀◀ (fast backward), || (pause).

### 4 Operation keys

- 🔍 : Searches for a track/file. For details on search operation, see **Search Operation (P.34)**.
- ◀◀ ▶▶ : Searches for the previous/next track/file.  
Touch and hold to fast forward or fast backward. (It will be cancelled automatically after about 50 seconds.)
- ▶|| : Plays or pauses.
- 📊 : Displays the Graphic Equalizer screen. **(P.68)**

### 5 Content list

- Touch the right side of the screen to display the Content list. Touch again to close the list.
- Displays the playing list. When you touch a track/file name on the list, playback will start.

### 6 Repeat/Random

- 🔄 : Repeats the current track/album. Each time you touch the key, repeat modes are switched in the following sequence: Song repeat (🔄), All songs repeat (🔄ALL), Repeat off (🔄OFF)
- 🎲 : Randomly plays all tracks in the current album. Each time you touch the key, random modes are switched in the following sequence: Song random (🎲), Random off (🎲OFF)

### 7 Indicator Items

- MUSIC: Identifies the music file.

## Search Operation

You can search music files by the following operations.

**1** Touch **Q**.

**2** Touch **▼**.



**3** Select a list type.

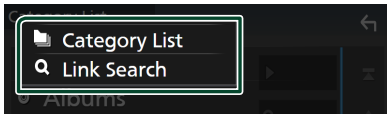

### NOTE

- For operations on the list screen, see **List screen (P.16)**.

## Category search

You can search for a file by selecting a category.

**1** Touch **Category List**.

**2** Touch the desired category.

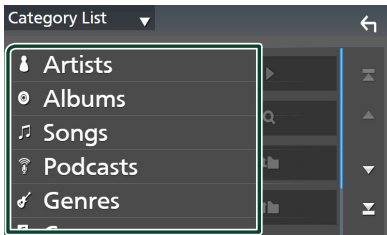

- The list corresponding to your selection appears.

**3** Touch to select the desired item in the list. Repeat this step until you find the desired file.

## Link search

You can search for a file of the same artist/album/genre/composer as that in the current track.

**1** Touch **Link Search**.

**2** Touch the desired tag type. You can select from artists, albums, genres and composers.

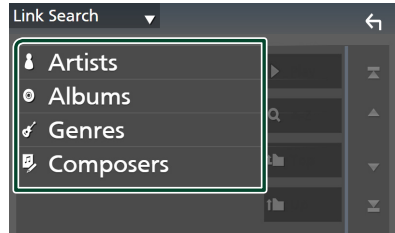

- The list corresponding to your selection appears.

**3** Touch the desired item in the content list.

# Radio

## Radio Basic Operation

Most functions can be controlled from the source control screen.

To listen to the Radio source, touch **Radio** icon on the source selection screen. (P.13)

### NOTE

- Set the remote control mode switch to **AUD** mode before starting operation, see **Switch the operation mode (P.74)**.

### Control screen

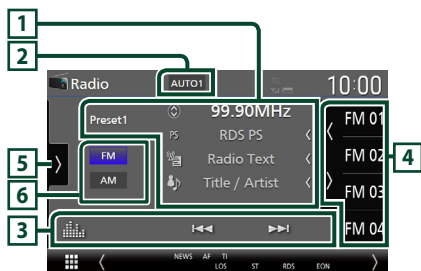

### Open the drawer

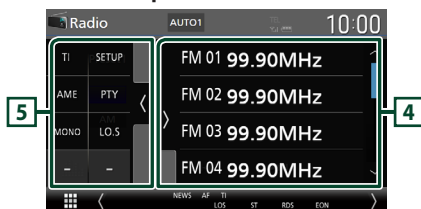

### Close the drawer

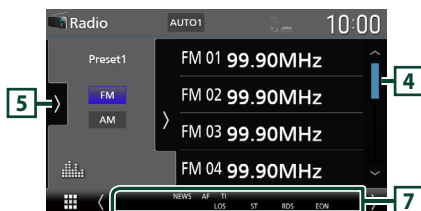

## 1 Information display

- Displays the information on the current station:
  - Frequency
  - Touching allows you to switch between Content A and Content B.
  - Content A: PS name, Radio Text, Title & Artist
  - Content B: PTY Genre, Radio Text plus
  - Preset#**: Preset number
- Change the text size of the information when the "Small Audio Text" is set to "ON"/"OFF" in the User Interface screen (P.60).

## 2 Seek mode

Touch to switch seek mode in the following sequence: **AUTO1**, **AUTO2**, **MANUAL**.

- AUTO1**: Tunes in a station with good reception automatically.
- AUTO2**: Tunes in the memorized stations one after another.
- MANUAL**: Switches to the next frequency manually.

## 3 Operation keys

- : Tunes in a station. The method of switching frequencies can be changed (see **2** Seek mode).
- : Displays the Graphic Equalizer screen. (P.68)

## 4 Preset list

- Touching allows you to change the display size.
- Recalls the memorized station.
- When touched for 2 seconds, stores the currently being received station in the memory.

## 5 Function panel

Touch the left side of the screen to display the function panel. Touch again to close the panel.

- TI** (FM only): Selects the traffic information mode. For details, see **Traffic Information (P.37)**.
- SETUP** (FM only): Displays the Radio SETUP screen. For details, see **Radio SETUP (P.38)**.
- AME**: Presets stations automatically. For details, see **Auto memory (P.36)**.

## Radio

- **PTY** (FM only) : Searches for a program by program type. For details, see **Search by program type (P.37)**.
- **MONO** (FM only) : Selects the Monaural reception mode.
- **LO.S** (FM only) : Turns the Local Seek function on or off.

### 6 Band keys

Switches bands (between FM and AM).

### 7 Indicator Items

- **ST** : A stereo broadcast is being received.
- **MONO** : The forced monaural function is on.
- **AF** : The AF search function is on.
- **EON** : The Radio Data System station is sending EON.
- **LOS** : The Local Seek function is on.
- **NEWS** : News bulletin interruption is in progress.
- **RDS** : Indicates the state of the Radio Data System station when the AF function is on.
  - White: Radio Data System is being received.
  - Orange: Radio Data System is not being received.
- **TI** : Indicates the reception state of traffic information.
  - White: TP is being received.
  - Orange: TP is not being received.

## Memory Operation

### Auto memory

You can store stations with good reception in the memory automatically.

#### 1 Touch desired band key.

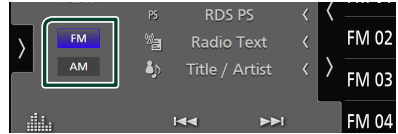

#### 2 Touch **>** on the left side of the screen. Touch **AME**.

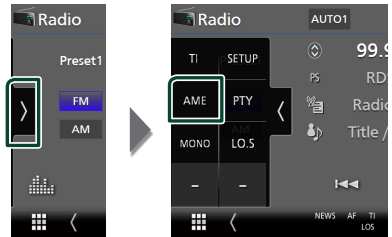

#### 3 Touch **Yes**.

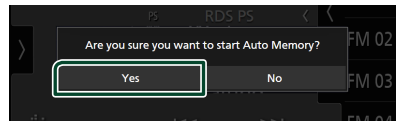

➤ Auto memory starts.

### Manual memory

You can store the currently being received station in the memory.

#### 1 Select the station you wish to store in the memory.

#### 2 Touch **FM#** (#:1-15) or **AM#** (#:1-5) in which you want to store the station for 2 seconds until a beep sounds.

## Selecting Operation

### Preset select

You can list and select memorized stations.

- 1 Touch  on the right side of the screen. Select a station from the list.

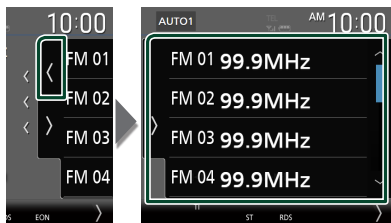

### Search by program type (FM only)

You can tune in the station broadcasting the specified type of program when listening to FM.

- 1 Touch  on the left side of the screen. Touch **PTY**.

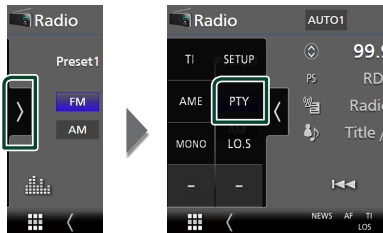

➤ TUNER PTY Mode screen appears.

- 2 Select a program type from the list.
- 3 Touch **Search**.

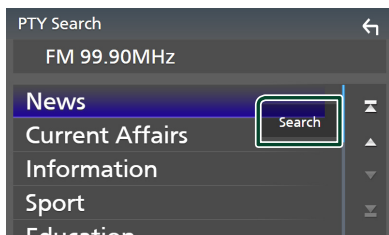

You can search for the station broadcasting the selected type of program.

## Traffic Information (FM only)

You can listen to and watch traffic information automatically when a traffic bulletin starts. However, this feature requires a Radio Broadcast Data System that includes TI information.

- 1 Touch  on the left side of the screen. Touch **TI**.

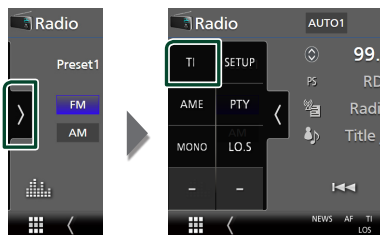

➤ Traffic information mode is set.

### When the traffic bulletin starts

The Traffic Information screen appears automatically.

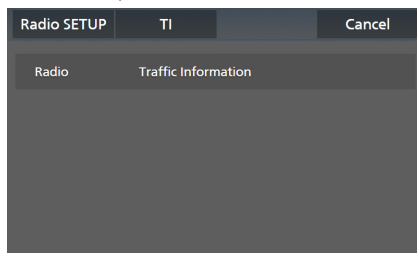

#### NOTE

- It is necessary to turn on the Traffic Information function in order to allow the Traffic Information screen to appear automatically.
- The volume setting made during reception of traffic information is automatically memorized. When the traffic information is received next time, this unit recalls the volume setting automatically.
- To cancel Traffic Information: Touch **Cancel**.

## Radio SETUP

You can set tuner related parameters.

- 1 Touch **>** on the left side of the screen. Touch **SETUP**.



► Radio SETUP screen appears.

- 2 Set each function as follows.

■ **NEWS**

Sets a news bulletin interrupt time. Default is "OFF".

■ **AF**

When station reception is poor, automatically switches to the station that is broadcasting the same program over the same Radio Data System network. Default is "ON".

■ **Regional**

Sets whether to switch to the station only in the specific region using the "AF" control. Default is "ON".

■ **Auto TP Seek**

When traffic information station reception is poor, automatically searches for a station that can be received better. Default is "ON".

■ **Language Select**

Selects a display language for the PTY function.

# Digital Radio

## Digital Radio Basic Operation

Most functions can be controlled from the source control screen.

To listen to Digital Radio source, touch **Digital Radio** icon on the source selection screen. **(P.13)**

### NOTE

- Set the remote controller mode switch to **AUD** mode before starting operation, see **Switch the operation mode (P.74)**.

### Control screen



### Open the drawer

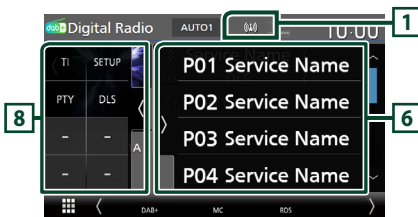

### Close the drawer



### 1 Indicator display

Displays the received signal strength.

### 2 Information display

- Displays the information on the current station:
  - Service Name
  - Touching allows you to switch between Content A, Content B and Content C.
  - Content A: DLS, PTY Genre
  - Content B: Song Title, Artist Name, Ensemble name
  - Content C: Now Playing, Next Program, Audio Quality
- Touch to switch between the Control and Information screen.

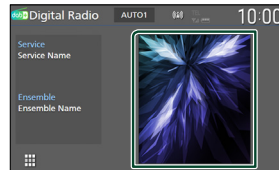

- Change the text size of the information when the "Small Audio Text" is set to "ON"/"OFF" in the User Interface screen **(P.60)**.

### 3 Seek mode

Touch to switch seek modes in the following sequence: **AUTO1**, **AUTO2**, **MANUAL**.

- AUTO1**: Tunes in a ensemble with good reception automatically.
- AUTO2**: Tunes in the memorized ensemble one after another.
- MANUAL**: Switches to the next ensemble manually.

### 4 Indicator display

**P#**: Preset number

**CH#**: Channel display

### 5 Operation keys

- : Displays the Service List screen. For details on search operation, see **Service search (P.41)**.
- : Tunes in a ensemble, service, and component. The seek mode switching can be changed. (see **3** Seek mode).
- : Displays the Graphic Equalizer screen. **(P.68)**

**6 Preset list**

- Touching **⏪** / **⏩** allows you to change the display size.
- Recalls the memorized service.
- When touched for 2 seconds, stores the currently being received service in the memory.

**7 Artwork/VU meter**

- Displays/hides artwork area.
- The picture data is displayed if available from current content.
- Touch to switch between the artwork and VU meter.

**8 Function panel**

Touch the left side of the screen to display the function panel. Touch again to close the panel.

- **TI**: Selects the traffic information mode. For details, see **Traffic Information (P.41)**.
- **SETUP**: Displays the Digital Radio SETUP screen. For details, see **Digital Radio SETUP (P.42)**.
- **PTY**: Searches for a program by program type. For details, see **Search by program type (P.40)**.
- **DLS**: Display the Dynamic Label Segment screen.

**9 Indicator Items**

- **DAB+**: Digital Radio is being received.
- **RDS**: Radio Data System is being received.
- **MC**: Receiving service is displayed.  
White: Primary Component is received.  
Orange: Secondary Component is received.
- **TI**: Indicates the reception state of traffic information.  
White: TP is being received.  
Orange: TP is not being received.

**Storing Service in Preset Memory**

You can store the current receiving service in the memory.

- 1 Select a service you wish to store in memory.**
- 2 Touch **⏪** on the right side of the screen.**

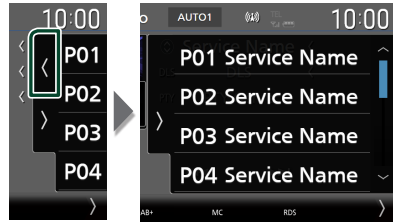

- 3 Touch **P#** (#:1-15) in which you want to store the station for 2 seconds until a beep sounds.**

**Selecting Operation**

**Search by program type**

You can tune in the station broadcasting the specified type of program when listening to Digital Radio.

- 1 Touch **⏩** on the left side of the screen. Touch **PTY**.**



> PTY Search screen appears.

- 2 Select a program type from the list.**



### 3 Touch Search.

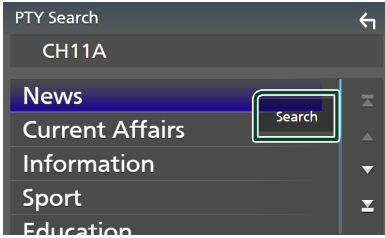

You can search for the station broadcasting the selected type of program.

### Service search

You can select a service from a list of all services received.

#### 1 Touch Q.



#### 2 Select the desired content from the list.

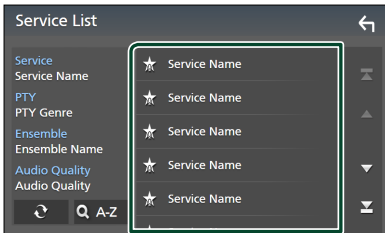

Touch and hold to find the latest service list.



Displays the keyboard screen.

Jump to the letter you entered (alphabet search).

## Traffic Information

You can listen to and watch traffic information automatically when a traffic bulletin starts. However, this feature requires a Digital Radio that includes TI information.

#### 1 Touch on the left side of the screen. Touch TI.



➤ Traffic information mode is set.

#### When the traffic bulletin starts

The Traffic Information screen appears automatically.

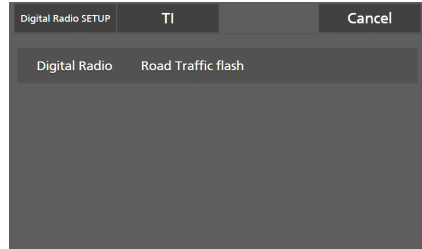

#### NOTE

- It is necessary to turn on the Traffic Information function in order to allow the Traffic Information screen to appear automatically.
- The volume setting made during reception of traffic information is automatically memorized. When the traffic information is received next time, this unit recalls the volume setting automatically.
- To cancel Traffic Information: Touch **Cancel**.

## Digital Radio SETUP

You can set Digital Radio related parameters.

- 1 Touch  on the left side of the screen. Touch **SETUP**.



➤ Digital Radio SETUP screen appears.

- 2 Set each function as follows.

### ■ Priority

If the same service is provided by Digital Radio during Radio Data System reception, automatically switches to Digital Radio. If the same service is provided by Radio Data System when reception of the service being provided by Digital Radio becomes poor, automatically switches to Radio Data System.

### ■ PTY Watch

If the service of the set program type begins with the ensemble being received, switches from any source to Digital Radio for service reception.

### ■ Announcement Select

Switches to the set Announcement service. For details, see **Announcement setup (P.42)**.

### ■ Antenna Power

Sets power supply to the Digital Radio antenna. Set to "ON" when the Digital Radio antenna in use is equipped with a booster. Default is "ON".

### ■ Related Service

When you select ON, the unit switches to a related service (if exists) when a Digital Radio service network is not available. Default is "OFF".

### ■ Language Select

Selects a display language for the PTY function.

## ■ Announcement setup

When the service for which ON is selected starts, switches from any source to Announcement to receive it.

- 1 Touch **Announcement Select** on the Digital Radio SETUP screen.

➤ The Announcement Select screen appears.

- 2 Touch each Announcement list and set on or off.

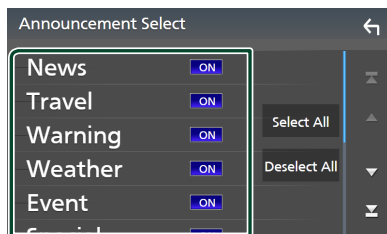

### ■ Select All

Turn on all announcements.

### ■ Deselect All

Turn off all announcements.

### NOTE

- The volume setting during reception of Announcement service is automatically stored. The next time the Announcement service is received, this unit recalls the volume setting automatically.

# Bluetooth Control

Using the Bluetooth function allows you to use various functions such as listening to the audio file and making/receiving a call.

## Information for using Bluetooth® devices



Bluetooth is a short-range wireless radio communication technology for mobile devices such as cell-phones, portable PCs, and other devices.

Bluetooth devices can be connected without cables and communication with each other.

### NOTE

- While driving, do not perform complicated operations such as dialing numbers, using the phonebook, etc. When you perform these operations, stop your car in a safe place.
- Some Bluetooth devices may not be connected to this unit depending on the Bluetooth version of the device.
- This unit may not work for some Bluetooth devices.
- Connecting conditions may vary depending on your environment.
- Some Bluetooth devices are disconnected when this unit is turned off.
- The Bluetooth devices cannot be used while using Apple CarPlay.
- The Bluetooth currently connected with other device is disconnected when an iPhone compatible with Apple CarPlay is connected.

## About the cell-phone and Bluetooth audio player

This unit conforms to the following Bluetooth specifications:

### Version

Bluetooth Ver. 5.0

### Profiles

#### Cell-phone:

HFP (V1.7) (Hands Free Profile)

SPP (Serial Port Profile)

PBAP (Phonebook Access Profile)

#### Audio player:

A2DP (Advanced Audio Distribution Profile)

AVRCP (V1.6) (Audio/Video Remote Control Profile)

#### Sound codec

SBC, AAC

### NOTE

- The units supporting the Bluetooth function have been certified for conformity with the Bluetooth Standard according to the procedure prescribed by Bluetooth SIG.
- However, it may be impossible for such units to communicate with your cell-phone depending on its type.

## Register the Bluetooth device

It is necessary to register the Bluetooth audio player or cell-phone in this unit before using the Bluetooth function.

You can register up to 10 Bluetooth devices.

### NOTE

- Up to 10 Bluetooth devices can be registered. If an attempt is made to register the 11th Bluetooth device, the Bluetooth device connected on the earliest date will be deleted to register the 11th one.
- This unit is compatible with the Apple Easy Pairing function. When an iPod touch or iPhone connected via USB terminal previously is connected again, an authentication dialog appears. Performing operation for authentication on this unit or iOS smartphone registers the smartphone as a Bluetooth device.

### 1 Press the **MENU** button.

➤ Popup menu appears.

### 2 Touch **SETUP**.



➤ SETUP Menu screen appears.

### 3 Touch **Bluetooth**.

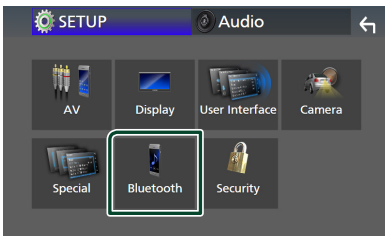

➤ Bluetooth Setup screen appears.

### 4 Touch **Select Device** on the Bluetooth Setup screen.

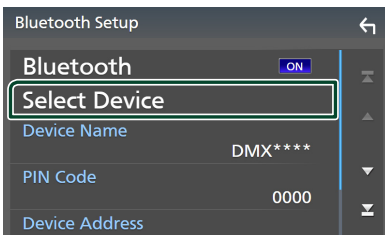

### 5 Touch **+0** on the Select Device screen.

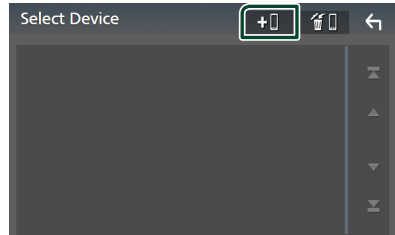

➤ Bluetooth pairing waiting dialog appears.

### NOTE

- You can also register an iPhone on the Apple CarPlay Device List screen. (P.24)
- When neither Apple CarPlay, Android Auto, nor a Bluetooth Hands-Free phone is connected, pressing and holding the  button displays Bluetooth pairing waiting dialog.

### 6 Search for the unit ("DMX\*\*\*\*") from your smartphone/cell-phone.

Complete steps 6 to 9 within 30 seconds.

### 7 Operate your smartphone/cell-phone according to the displayed messages.

- **Confirm the request both on the smartphone/cell-phone.**

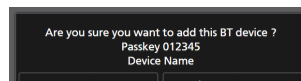

- **Input the PIN Code in your smartphone/cell-phone.**

PIN Code is set to "0000" as the default.

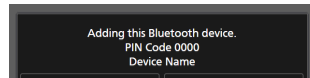

## 8 Select the function you want to use.

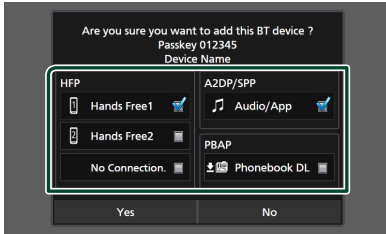

### ■ HFP Hands Free1 / Hands Free2 / No Connection.

Select the hands-free number to connect.

### ■ A2DP/SPP Audio/App

Select if you want to use the audio player app in your smartphone over A2DP, and the other apps in your smartphone over SPP.

### ■ PBAP Phonebook DL

Select if you want to transfer your phonebook data.

#### NOTE

- To select **Phonebook DL**, first select **Hands Free1** or **Hands Free2** for HFP.

## 9 Touch Yes.

When data transmission and connection have completed, the Bluetooth connection icon appears on the screen.

#### NOTE

- When registering the iPhone that is available for Apple CarPlay wirelessly, a confirmation message appears.
  - Yes**: Displays the Apple CarPlay screen for wireless connection.
  - No**: Apple CarPlay is not connected. When using Apple CarPlay, see **Select an Apple CarPlay device (P.24)**.

## Bluetooth Setup

#### NOTE

- The Bluetooth Setup is disabled while using Apple CarPlay.

### 1 Press the **MENU** button.

- Popup menu appears.

### 2 Touch **SETUP**.

- SETUP Menu screen appears.

### 3 Touch **Bluetooth**.

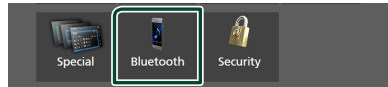

- Bluetooth Setup screen appears.

See the following section for each setting.

- Connect the Bluetooth device (**P.45**)
- Change the PIN Code (**P.47**)
- Change the device name (**P.46**)

## ■ Connect the Bluetooth device

### 1 Touch **Select Device** on the Bluetooth Setup screen.

### 2 Touch the name of the device you want to connect.

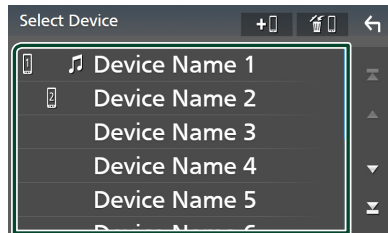

- Profile select screen appears.

#### NOTE

- If the icon is lighted, it means that the unit will use that device.
- You cannot select an Android smartphone connected as an Android Auto device.

3 Set each profile as follows.

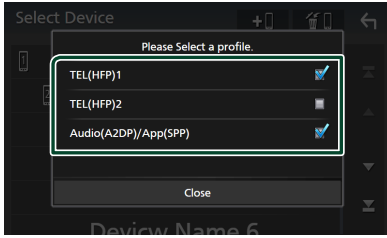

■ TEL (HFP) 1, TEL (HFP) 2

Select when the device is connected with the unit as hands-free phone 1 or 2.

■ Audio (A2DP)/App (SPP)

Select to interwork with an application installed in a smartphone or to use as an audio player.

4 Touch **Close**.

**To delete the registered Bluetooth device**

1 Touch on the Select Device screen.

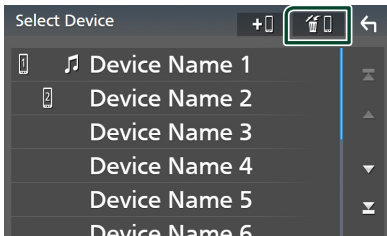

2 Touch the device name to check.

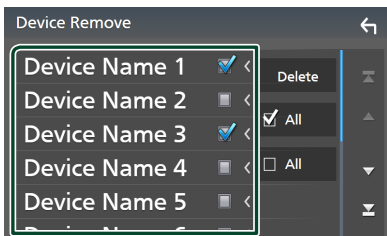

■  All

Selects all Bluetooth devices.

■  All

Clears all check marks.

**NOTE**

- You cannot select an Android smartphone connected as an Android Auto device.

3 Touch **Delete**.

➤ Confirmation message appears.

4 Touch **Yes**.

➤ All the selected device(s) is deleted.

**NOTE**

- If the device compatible with wireless Apple CarPlay is deleted, the same device is deleted from the Apple CarPlay device list screen.

**Change the device name**

1 Touch **Device Name** on the Bluetooth Setup screen.

➤ Change Device Name screen appears.

2 Touch and hold .

3 Input the device name.



4 Touch **Enter**.

## Change the PIN Code

- 1 Touch **PIN Code** on the Bluetooth Setup screen.
  - Change PIN Code screen appears.
- 2 Touch and hold .
- 3 Input the PIN Code.

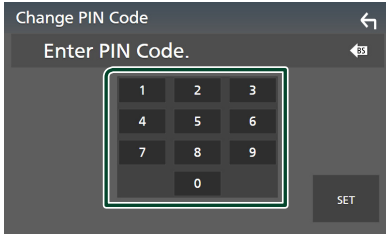

- 4 Touch **SET**.

## Playing the Bluetooth Audio Device

Most function can be controlled from the source control screen.

To select Bluetooth source, touch **Bluetooth** icon on the source selection screen. (P.13)

### NOTE

- The Bluetooth audio source is disabled while using Apple CarPlay.
- The Bluetooth audio source is disabled when the device set as Audio(A2DP)/App(SPP) is using Android Auto.

## Bluetooth basic operation



### 1 Artwork/VU meter

- Displays/hides artwork area.
- Touch to switch between the artwork and VU meter.

### 2 Play mode indicator/Playing time

▶, **II**: Current play mode indicator

Meanings of individual icons are as follows:



- ▶ (play), ▶▶ (fast forward), ◀◀ (fast backward), **II** (pause), ■ (stop).

### 3 Operation keys \*

- : Searches for a file. See **File search (P.48)**.

- ◀◀ ▶▶: Searches for the previous/next content.









Touch and hold to fast forward or fast backward. (It will be cancelled automatically after about 50 seconds.)

- ▶: Plays.
- **II**: Pauses.
- : Displays the Bluetooth Setup screen. (P.45)
- : Displays the Graphic Equalizer screen. (P.68)

### 4 KENWOOD Music Mix

Bluetooth audio devices can be switched easily to play music. See **KENWOOD Music Mix (P.48)**.

### 5 / \*

- : Repeats the current track/folder. Each time you touch the key, repeat modes are switched in the following sequence: File repeat () , Folder repeat () , All songs repeat () , Repeat off ()
- : Randomly plays all tracks in the current folder. Each time you touch the key, random modes are switched in the following sequence: Folder random () , All random () , Random off ()

### 6 Information display \*

- Displays the name of track information.
- Connected device name.
- Change the text size of the information when the "Small Audio Text" is set to "ON"/"OFF" in the User Interface screen (P.60).

\* These items appear only when the audio player which supports AVRCP profile is connected.

**NOTE**

- The operation keys, indications and information displayed on the screen differ depending on the connected device.
- If the operation keys do not appear, operate from the player.
- Depending on your cell-phone or audio player, sound may be heard and controlled but text information may not appear.
- If the volume is too low, raise it on your cell-phone or audio player.





**KENWOOD Music Mix**

Up to 5 Bluetooth audio device can be connected and switched easily to play music.



**1** Touch .

➤ A list of registered devices is displayed.

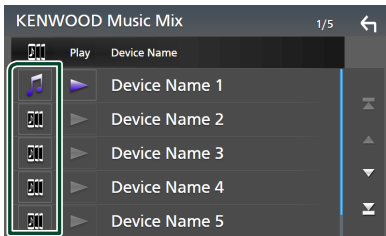

**2** Touch  of device name you want to connect.

- Touching  displays the Bluetooth device connection setup screen. (P.45)
- Touching  on the left of the connected device (   ) disconnects this device.





-  : Device used normally.
-  : Device used for KENWOOD MusicMix

**3** Touch  (white) on the left of the name of the device to be played.

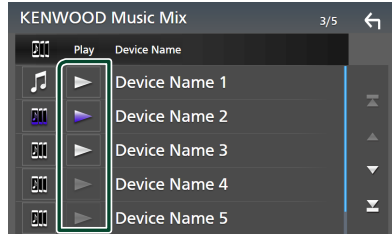
 (white) changes to  (purple) and starts playback.



-  (Gray) : Not connected.
-  (White) : Connected.
-  (Purple) : During playback.

**4** Touch .

**NOTE**

- If a connected Bluetooth audio device is operated to play music, connections are switched.
- When a Bluetooth source is switched to another one, its settings are deleted and the connection is restored to the connection before source switching.
- You cannot select an Android smartphone connected as an Android Auto device.

**File search**

**1** Touch .

**2** Touch the desired file or folder.

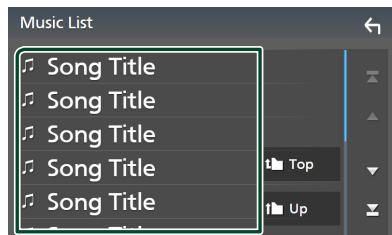

When you touch a folder its contents are displayed.



### 3 Touch the desired item in the content list.

► Playback starts.

#### NOTE

- For operations in the list screen, see **List screen (P.16)**.

## Using the Hands-Free Unit

You can use the telephone function by connecting the Bluetooth telephone to this unit.

#### NOTE

- If you use the hands-free function frequently, move the TEL short-cut key (icon) to the Home screen. **(P.14)**
- While Apple CarPlay or Android Auto is connected, the Bluetooth Hands-Free function and two Bluetooth devices connections cannot be used. Only the Apple CarPlay or Android Auto Hands-Free function can be used.

## Make a call

1 Press the **HOME** button.

2 Touch .

3 Touch **TEL**.

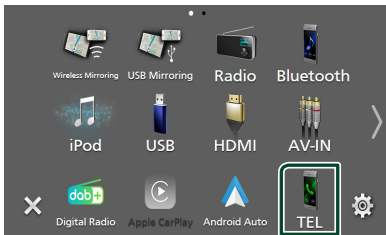





► Hands Free screen appears.

#### NOTE

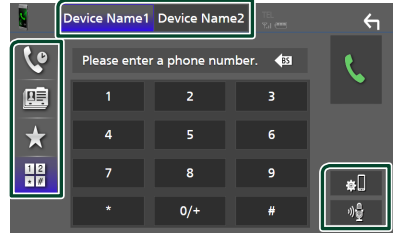
- If your cell-phone supports PBAP, you can display the phonebook and call lists onto the touch panel screen when the cell-phone is connected.
  - Phonebook: up to 1000 entries
  - Up to 50 entries including dialed calls, received calls, and missed calls



### 4 Select a dialing method.



- : Call using call records
- : Call using the phonebook
- : Call using the preset number
- : Call by entering a phone number

#### ● Select the cell-phone to use

When you connect two cell-phones

1) Touch   to select the phone you want to use.

#### ● Bluetooth Setup

1) Touch .  
Bluetooth Setup screen appears.

#### ● Voice Recognition

1) Touch . **(P.51)**

#### NOTE

- Status icons such as battery and antenna icons may differ from those displayed on the cell-phone.
- Setting the cell-phone in the private mode can disable the hands-free function.



## Bluetooth Control

### Call using call records

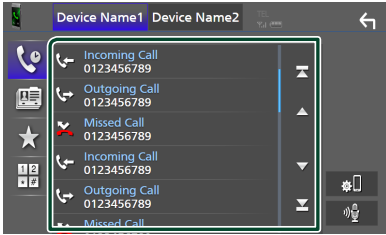
- 1 Touch .
- 2 Select the phone number from the list.



### Call using the phonebook

- 1 Touch .
- 2 Touch  **A-Z**.
- 3 Select the initial.

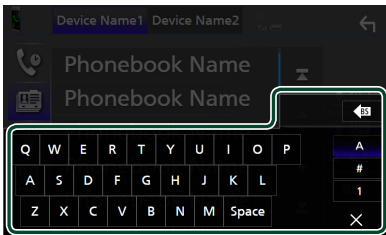

- Characters with no corresponding name will not appear.
- A first character with an accent character such as “ü” can be searched for with a non-accent character “u”. A character with an accent character in a sentence cannot be searched for.

- 4 Select the person you want to call from the list.

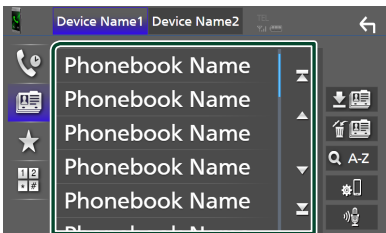

- 5 Select the phone number from the list.

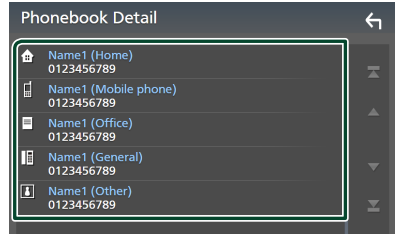

#### NOTE

- You can sort the phone numbers in the list by last name or first name. For details, see **Hands-Free Setup (P.53)**.

### Call using the preset number

- 1 Touch .
- 2 Touch the name or phone number.

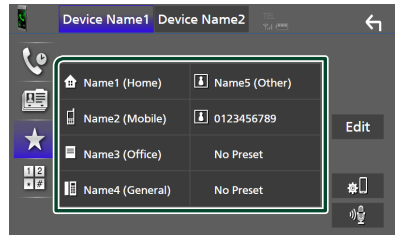

### Call by entering a phone number

- 1 Touch .
- 2 Enter a phone number with number keys.

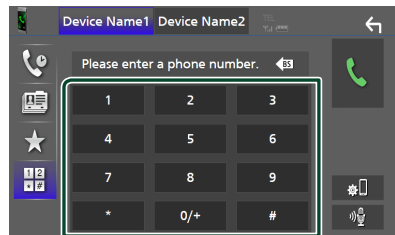

- 3 Touch .

## Voice Recognition

You can access the voice recognition function of the cell-phone connected to this unit. You can search the cell-phone phonebook by voice. (The functionality depends on the cell-phone.)

### 1 Press the button for 1 second.

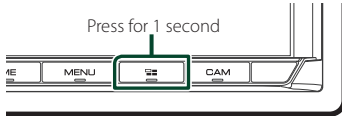

➤ Voice Recognition screen appears.

### 2 Start speaking.

#### NOTE

- You can use the voice recognition function by touching  on the Hands Free screen.
- You can use the voice recognition function for the connected cell-phone if you selected **Hands Free1** or **Hands Free2** for HFP when registered.

## Receive a call

### 1 Touch to answer a phone call or to reject an incoming call.

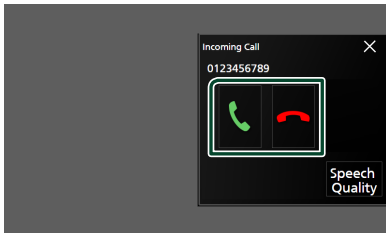

#### NOTE

- When shifting the gear to the reverse (R) position and monitoring the picture from the rear view camera, this screen does not appear even if a call comes in.

## To end call

### 1 While talking, touch .

## Operations during a call

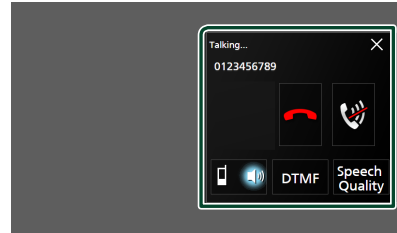

### ● Adjust the volume of your voice

- 1) Touch **Speech Quality**.
- 2) Touch ◀ or ▶ for **Microphone Level**.

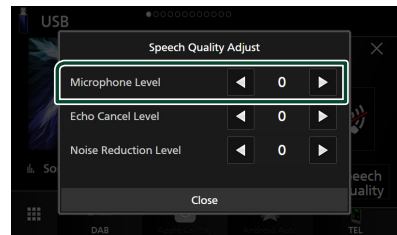

### ● Adjust the receiver volume

Press the ▼ or ▲ button.





### ● Mute your voice

Touch  to mute or not to mute your voice.

### ● Output the dial tone

Touch **DTMF** to display the tone input screen. You can send tones by touching desired keys on the screen.

### ● Switching between speaking voice output destinations

Touching  /  each time switches speaking voice output destinations between the cell-phone and the speaker.

## Bluetooth Control

### ● Call-waiting

When you receive a new call while talking on the phone, you can answer the newly received call by touching . The current call is put on hold.

Each time you touch , the caller will change to the other one.

When you touch , the current call will end to be switched to the call waiting on hold.

### ● To close the Hands-Free popup screen

Touch  to close the Hands-Free popup screen.

#### To display it again

- 1 Press the **HOME** button.
- 2 Touch .
- 3 Touch **TEL.**

## Phone number preset

You can register frequently used phone numbers in this unit.

1 Touch .

2 Touch **Edit**.

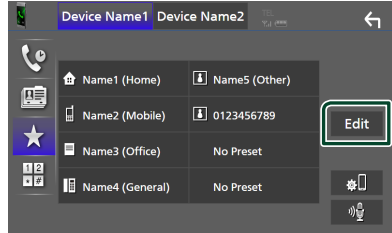

3 Select where to preset.

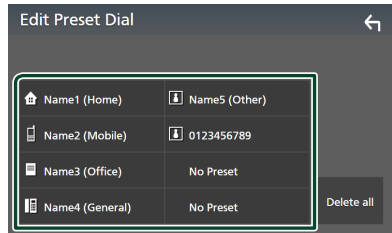

#### ■ Delete all

To delete all preset numbers, touch **Delete all** and then touch **Yes** on the confirmation screen.

4 Select how to preset.

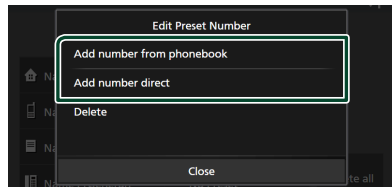

#### ■ Add number from phonebook

Select the number to preset from the phonebook. See **Call using the phonebook (P.50)**.

#### ■ Add number direct

Enter the telephone number directly and touch **SET**. See **Call by entering a phone number (P.50)**.

### ■ Delete

To delete a preset number, touch **Delete** and then touch **OK** on the confirmation screen.

## Phonebook transfer

You can transfer phonebook data from your Bluetooth smartphone using PBAP.

- 1 Touch .
- 2 Touch .

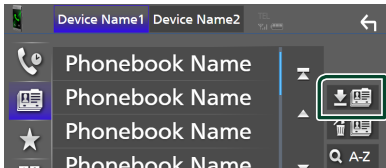

➤ Phonebook data transfer starts.

### NOTE

- If the Phonebook contains more than 1000 entries, Phonebook data cannot be transferred.
- If no Phonebook has been downloaded, touching **Download Phonebook Now** will start downloading the Phonebook.

## Phonebook deletion

- 1 Touch .
- 2 Touch the name to check.

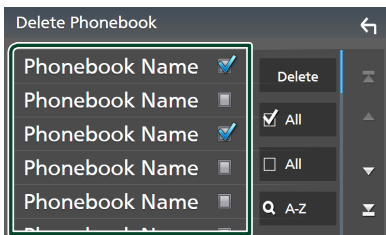

- **All**  
Checks all boxes.
- **All**  
Clears all check marks.

- 3 Touch **Delete**.  
➤ Confirmation message appears.
- 4 Touch **Yes**.

## Hands-Free Setup

You can make various settings for the Hands-Free function.

- 1 Press the **MENU** button.  
➤ Popup menu appears.
- 2 Touch **SETUP**.

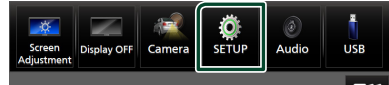

➤ SETUP Menu screen appears.

- 3 Touch **Bluetooth**.

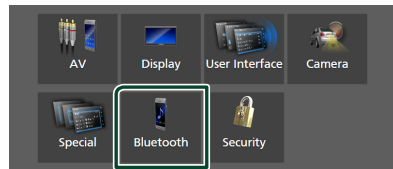

➤ Bluetooth Setup screen appears.

- 4 Touch **TEL SETUP**.  
➤ TEL SETUP screen appears.
- 5 Set each function as follows.

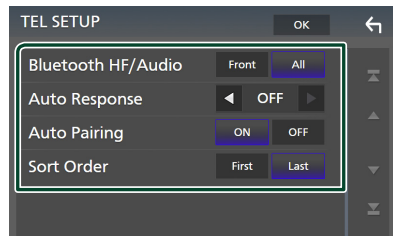

### ■ Bluetooth HF/Audio

Select the speakers to output the sound from the cell-phone (such as phone call voice and ringing tone) and Bluetooth audio player.

**Front**: Outputs sound from the front speakers.

**All** (Default): Outputs sound from all speakers.

## Bluetooth Control

### ■ Auto Response\*

Set the automatic response time to pick-up an incoming call.

**OFF** (Default): Turns off the Automatic response function.

**1 / 5 / 10 / 15 / 20 / 25 / 30**: Sets the ringing time (second).

### ■ Auto Pairing

When set to "ON", the Apple Auto Pairing function is turned on to automatically register the iPod touch or iPhone connected to this unit.

**ON** (Default): Turns on the Apple Auto Pairing function.

**OFF**: Turns off the Apple Auto Pairing function.

### ■ Sort Order

Set how to sort the data in the cell-phone phonebook.

**First**: Sorts data by the first name.

**Last** (Default): Sorts data by the last name.

\* Either the auto response time set on this unit or the time set on the cell-phone, whichever is shorter takes effect.

## 6 Touch OK.

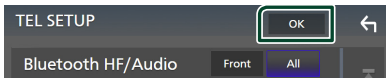

# Other External Components

## View Camera

### NOTE

- To connect a camera, see **Connecting the camera (P.86)**.
- To use a rear view camera, a REVERSE lead connection is required. **(P.81)**
- If **Rear Camera Interruption** is active the camera screen is displayed when you shift the gear to the reverse (R) position.
- The camera whose view was displayed last is kept and the same camera view will be displayed the next time. If its assignment setting is changed, the rear camera view is displayed.
- Rear/front camera interruption screen is not kept as the camera screen which will be displayed the next time.

### Display the camera screen

#### 1 Press the **MENU** button.

- Popup menu appears.

#### 2 Touch **Camera**.

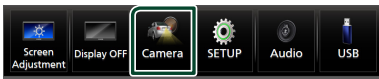

- View camera screen appears.

#### 3 Adjust each item as follows.

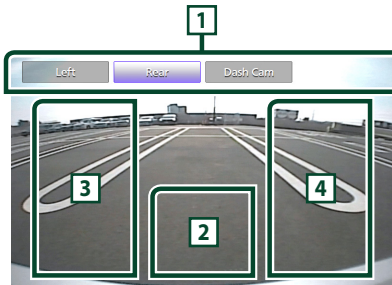

#### 1 **Camera Switching Keys** \*1

Touch to switch the view camera. It is necessary to set "Camera Assignment Settings" beforehand except "Rear". See **To set up the camera assignment settings (P.56)**.

#### 2 **Camera off**

Touch to exit the camera screen.

#### 3 **Switching the Guideline** \*2

Touching each time turns on or off the guideline.

#### 4 **Switching the Angle** \*2

Touching each time changes camera angles.

\*1 When two or more cameras of rear, front, dashboard, left, and right are connected with this unit.

\*2 Only when the rear camera screen is displayed and CMOS-3xx series is connected with this unit as the rear camera.

### Camera Setup

#### 1 Press the **MENU** button.

- Popup menu appears.

#### 2 Touch **SETUP**.

- SETUP Menu screen appears.

#### 3 Touch **Camera**.

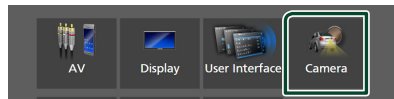

- Camera screen appears.

#### 4 Set each item as follows.

##### ■ **Camera Assignment Settings**

Set up the camera assignment. See **To set up the camera assignment settings (P.56)**.

##### ■ **Rear Camera Interruption**

**ON**: Displays the picture from the rear view camera when you shift the gear to the reverse (R) position.

**OFF** (Default): Select this when no camera is connected.

##### ■ **Rear Camera Message** \*1

**Always display** (Default): Always displays the caution message on the rear camera interruption screen.

**Clear after 5 seconds**: Displays the caution message for about 5 seconds on the rear camera interruption screen.

## Other External Components

### ■ Rear Camera for Car interface

**ON:** Select when you connected an external system unit. Neither keys nor titles are displayed.

**OFF (Default):** Select when you connected a rear camera.

### ■ Rear Camera Settings \*2

Adjusts the CMOS-3xx series with ID 1 ("Rear Camera") set. For details, see the instruction manual of your camera.

### ■ Parking Guidelines

You can display parking guidelines to enable easier parking when you shift the gear to the reverse (R) position.

Default is "ON".

### ■ Guidelines SETUP

If you select **ON** for **Parking Guidelines**, you can adjust the parking guidelines. See **To adjust the parking guidelines (P.57)**.

### ■ Front Camera Settings \*3

Adjusts the CMOS-3xx series with ID 2 ("Front Camera") set. For details, see the instruction manual of your camera.

### ■ Front Camera Interruption \*4

**10 sec / 15 sec (Default) / 20 sec:** The front camera screen is displayed when return the gear from the reverse (R) position.

**OFF:** Cancel.

\*1 To use the function, it is necessary to set **Rear Camera Interruption** to **ON**.

\*2 When CMOS-3xx series is connected with this unit.

\*3 To use the function, it is necessary to connect CMOS-3xx series and to set **Camera Assignment Settings** to **Front**. (P.56)

\*4 To use the function, it is necessary to set **Rear Camera Interruption** to **ON**, to set **Rear Camera for Car interface** to **OFF**, and to set **Camera Assignment Settings** to **Front**. (P.56)

## ■ To set up the camera assignment settings

**1** Touch **Camera Assignment Settings** on the Camera screen. (P.55)

**2** Select the item to set up.

### ■ FRONT VIEW CAMERA / DASH CAM

Set the camera assignment from view camera connected to Front view camera/Dashboard camera input terminal.

### ■ AV-IN

Set the camera assignment from view camera connected to AV-IN input terminal.

**3** Select the view camera to set up.

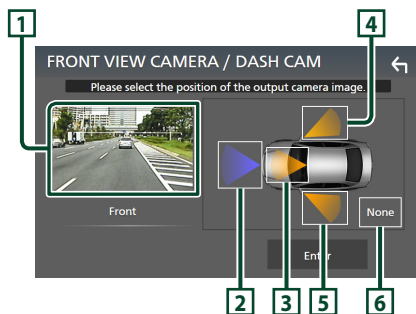

**1** Picture from view camera

Displays the picture from the view camera connected to the input terminal to be set. (P.86)

**2** Front

Assign front position to the view camera connected to the selected input terminal.

**3** Dashboard Camera

Assign dashboard camera position to the view camera connected to the selected input terminal.

**4** Right

Assign right position to the view camera connected to the selected input terminal.

**5** Left

Assign left position to the view camera connected to the selected input terminal.

**6** None

Assign no position to the view camera connected to the selected input terminal.



#### 4 Touch Enter.

##### NOTE

- The screen shot above is for the **FRONT VIEW CAMERA / DASH CAM** setting screen. It may be different from the one for **AV-IN**.
- The Dashboard Camera can be selected when it is connected. **(P.86)**

### To adjust the parking guidelines

##### NOTE

- Install the rear view camera in the appropriate position according to the instruction manual supplied with the rear view camera.
- When adjusting the parking guidelines, make sure to apply the parking brake to prevent the car from moving.

1 Touch **Parking Guidelines** in the Camera screen and set to **ON**. **(P.55)**

2 Touch **Guidelines SETUP** on the Camera screen.

3 Adjust the parking guidelines by selecting the  mark.

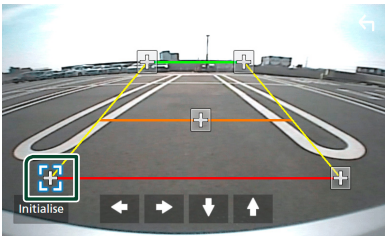

4 Adjusting the position of the selected mark.

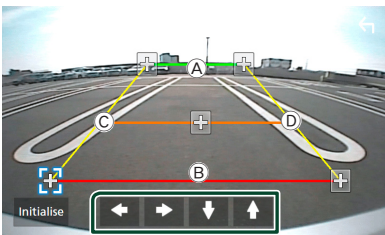

Make sure that lines **(A)** and **(B)** are horizontally parallel, and that lines **(C)** and **(D)** are of the same length.

##### NOTE

- Touch **Initialise** and then touch **Yes** to set all the  marks to their initial default position.

## Use Dashboard Camera

A Dashboard Camera, DRV-N520 (optional accessory), connected to this unit lets you play video-recorded data and so on.

For details, see the instruction manual of the Dashboard Camera DRV-N520 (optional accessory).

##### NOTE

- To connect a dashboard camera, see **Connecting the camera (P.86)**.
- To use the dashboard camera function, it is necessary to set "Camera Assignment Settings" to "Dashboard Camera". **(P.56)**

### Display the dashboard camera screen

1 Press the **MENU** button.  
➤ Popup menu appears.

2 Touch **Camera**.

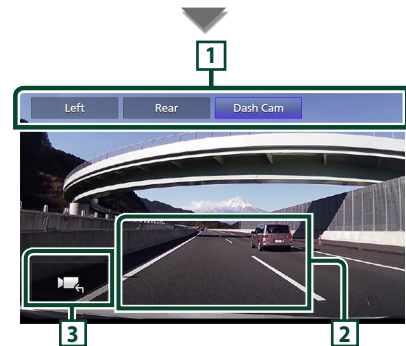
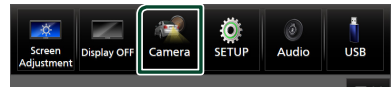

#### 1 Camera Switching Keys

Touch to switch the view camera. It is necessary to set "Camera Assignment Settings" beforehand except "Rear". See **To set up the camera assignment settings (P.56)**.

## Other External Components

### 2 Camera off

Touch to exit the camera screen.

### 3 Key display

Touch to display the dashboard camera control keys.

## External audio/video players (AV-IN)

- 1 Connect an external component to the AV-IN input terminal. (P.83)
- 2 Select AV-IN as the source. (P.13)
- 3 Turn on the connected component and start playing the source.

### NOTE

- To select the AV-IN source, it is necessary to set "AV-IN" to "None" in **Camera Assignment Settings**. (P.56)

## HDMI source

- 1 Connect your smartphone to the HDMI input terminal. (P.83)  
Use HDMI cable KCA-HD100 (optional accessory).
- 2 Select HDMI as the source. (P.13)
- 3 Start an application or playback on your smartphone.

## TV tuner

You can connect the TV tuner (commercially available) with this unit and watch TV.

### Preparation

- When you use TV control function, connect the TV tuner (commercially available) and set 3rd Party TV Tuner Control in **AV Setup (P.63)** to ON.
- The TV tuner can be controlled with its supplied remote control through the remote sensor on the front panel of this unit.

- 1 Select TV as the source. (P.13)
- 2 Touch Key display area.

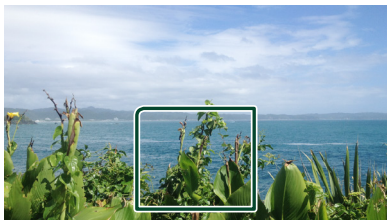

- 3 Touch TV Ctrl.

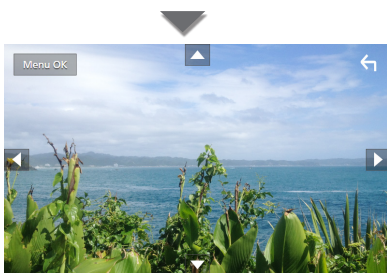

■ Displays the menu/Enters selected item  
Touch **MENU/OK**.

■ Moves the cursor  
Touch ▲, ▼, ◀, ▶.

■ Exits menu control  
Touch ◀.

# Setup

## Monitor Screen Setup

You can adjust the image quality of video, menu screen, etc.

- 1 Press the **MENU** button.  
➤ Popup menu appears.
- 2 Touch **Screen Adjustment**.

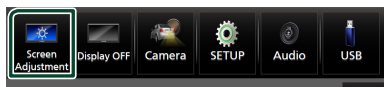

➤ Screen Adjustment screen appears.

- 3 Adjust each setting as follows.

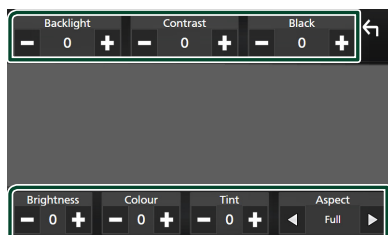

### ■ Backlight / Contrast / Black / Brightness / Colour / Tint

Adjust each setting.

### ■ Aspect

Select a screen mode.

**Full**: Changes the aspect ratio of video and displays video fully on the screen.

**Normal**: Displays video at the ratio of 4:3.

**Auto**:

USB device: Displays video fully (vertically or horizontally) with no ratio change.

### NOTE

- Settings to adjust vary depending on the current source.

## System Setup

- 1 Press the **MENU** button.  
➤ Popup menu appears.
- 2 Touch **SETUP**.

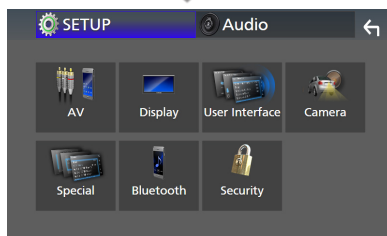

See the following section for each setting.

- Set up AV ([P.63](#))
- Set up display ([P.61](#))
- Set up the user interface ([P.59](#))
- Set up camera ([P.55](#))
- Set up special ([P.61](#))
- Set up Bluetooth ([P.45](#))
- Set up security ([P.9](#))

## User Interface Setup

You can setup user interface parameters.

- 1 Press the **MENU** button.  
➤ Popup menu appears.
- 2 Touch **SETUP**.  
➤ SETUP screen appears.

- 3 Touch **User Interface**.



➤ User Interface screen appears.

- 4 Set each parameter as follows.

## Setup

### ■ Small Audio Text

Change the text size for the source control screen.

**ON** (Default): Change the text size smaller.

**OFF**: Cancel.

### ■ Steering Remote Controller

Sets the desired function in the steering remote controller. (Contact your KENWOOD dealer for details.)

### ■ Beep

Turn the key touch tone on or off.  
Default is "ON".

### ■ Widget SETUP

Set up the widget displayed on the Home screen. (P.19)

### ■ Vehicle Adaptor Information \*1

Displays the vehicle information.  
This function requires a commercial adaptor.  
Consult your KENWOOD dealer for details.

### ■ Beep for Parking distance control \*1

Sets whether to generate a warning tone when the onboard proximity sensor detects a human or object.

Consult your KENWOOD dealer for details.

### ■ Parking Distance Display \*1

You can display information about obstacles around the car.

**ON**: Always displays information.

**Dyn.** (Default): Displays information when the sensor detects obstacles.

**OFF**: Cancels.

This function requires a commercial adaptor.  
Consult your KENWOOD dealer for details.

### ■ Parking Distance Position \*1

Select where information about obstacles is displayed on the screen (left or right).

"Left"/"Right" (Default)

This function requires a commercial adaptor.  
Consult your KENWOOD dealer for details.

### ■ Language Select

Select a language.

### ■ Time Format

Select the time display format.

"12-Hour"/"24-Hour" (Default)

### ■ Clock

**GPS-SYNC** (Default): Synchronizes the clock time with the GPS.

**Manual**: Set the clock manually.

### ■ Time Zone

Select the time zone.

### ■ Clock Adjust

If you select **Manual** for Clock, adjust the date and time manually. (P.60)

**\*1 This setting is available when a commercial adaptor is connected.**

## Adjust the date and time manually

- 1 Touch **Clock** on the User Interface screen.
- 2 Select **Manual**.
- 3 Touch **Time Zone** on the User Interface screen.
- 4 Select the time zone.
- 5 Touch **Clock Adjust** on the User Interface screen.
- 6 Adjust the date, then adjust the time.

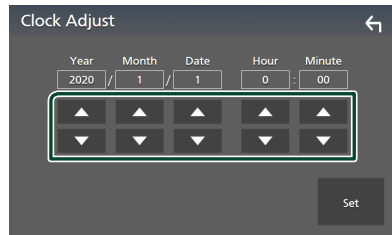

- 7 Touch **Set**.

## Special Setup

You can setup special parameters.

- 1 Press the **MENU** button.
  - Popup menu appears.
- 2 Touch **SETUP**.
  - SETUP screen appears.
- 3 Touch **Special**.

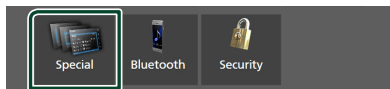

➤ Special screen appears.

- 4 Set each parameter as follows.

### ■ DEMO

Select the demonstration mode. Default is "ON".

### ■ Software Information

Confirm the software version of this unit.  
**(P.61)**

### ■ Open Source Licenses

Display the open source licenses.

### ■ Initialise

Touch **Initialise** and then touch **Yes** to set all the settings to the initial default settings.

- Audio SETUP Memory is not initialized.

## ■ Software Information

You can confirm the software version of this unit.

- 1 Touch **Software Information** in the Special screen.
- 2 Confirm the software version.

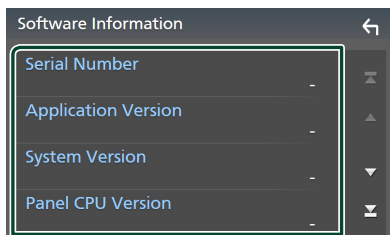

### NOTE

- For how to update the software, see the relevant update procedure manual which comes with the software.

## Display Setup

- 1 Press the **MENU** button.
  - Popup menu appears.
- 2 Touch **SETUP**.
  - SETUP screen appears.
- 3 Touch **Display**.

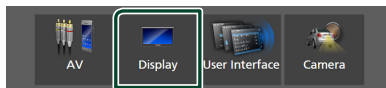

➤ Display screen appears.

- 4 Set each parameter as follows.

### ■ Dimmer

Select the dimmer mode.

**OFF**: Does not dim the display and keys.

**ON**: Dims the display and keys.

**SYNC** (Default): Turns the dimmer function on or off when the vehicle light control switch is turned on or off.

### ■ OSD Clock

Select if you want to display the clock while the screen is off, or while watching video files on USB, etc.

"ON" (Default)/"OFF"

### ■ Key Colour

You can set the key illumination color.  
**(P.62)**

### ■ Wallpaper Customize

You can change the wallpaper image or color. **(P.62)**

### ■ Viewing Angle

If it is hard to see the image on the screen evenly, adjust the viewing angle. The smaller the (negative) value, the more whitish the image on the screen looks.

"0" (Default)/"-1"/"-2"/"-3"

### ■ Screen transition effect

Select whether to use the screen transition effect when the source control screen is switched to the Home screen.

"ON" (Default)/"OFF"

## Setup

### ■ Customizing the key color

You can set the key illumination color.

- 1 Touch **Key Colour** on the Display screen.
- 2 Touch the desired color.

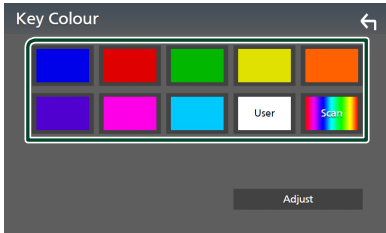

#### ■ User

The color you have set in the process of **Adjust** is registered.

#### ■ Scan

You can set the key color to continuously scan through the color spectrum.

- 3 Touch .

### *To register an original color*

You can register your original color.

- 1 Touch **User** on the Key Colour screen.
- 2 Touch **Adjust**.
- 3 Use **-** and **+** to adjust each color value.

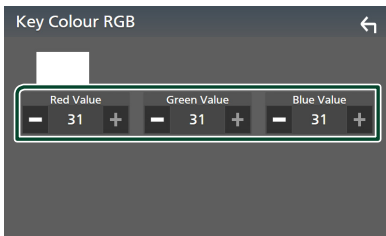

- 4 Touch .

### ■ Change the wallpaper image or color

- 1 Touch **Wallpaper Customize** on the Display screen.
- 2 Select an image.

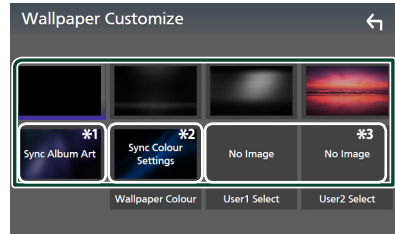

\*1 The album art currently being displayed is used as a wallpaper.

\*2 Select a wallpaper color in advance.

\*3 Select an original image in advance.

### *To select wallpaper color*

- 1 Touch **Wallpaper Colour** on the Background screen.
- 2 Select a wallpaper color.



\*1 The color you have selected at **Key Colour** is added on the image. If you select "Scan" at **Key Colour**, you cannot select this image.

- 3 Touch .

### To register an original image

You can load an image from the connected USB device and set it as the wallpaper image. Before starting this procedure, it is necessary to connect the device which has the image to load.

- 1 Touch **User1 Select** or **User2 Select** on the Wallpaper Customize screen.
- 2 Select the image to load.

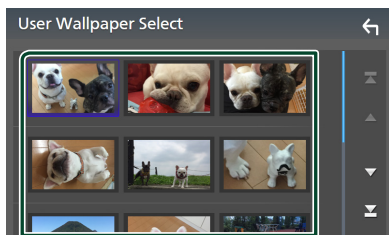

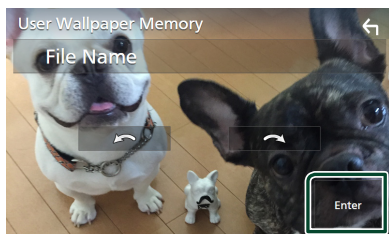

- 3 Touch **Enter**.



- The selected image is loaded and the display returns to the Wallpaper Customize screen.

#### NOTE

- Touching  rotates the image counter-clockwise.
- Touching  rotates the image clockwise.
- Picture files: JPEG (.jpg, .jpeg), PNG (.png), BMP (.bmp)

## AV Setup

You can set AV parameters.

- 1 Press the **MENU** button.
  - Popup menu appears.
- 2 Touch **SETUP**.
  - SETUP screen appears.
- 3 Touch **AV**.

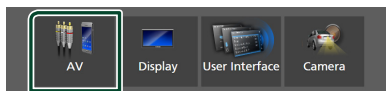

- AV screen appears.

- 4 Set each parameter as follows.

#### ■ Android Auto Device Select (DMX8020DABS)

Select the device to be used in the Android Auto mode. (P.27)

#### ■ Apple CarPlay Device List (DMX8020DABS)

Select the device to be used in the Apple CarPlay mode. (P.24)

#### ■ Speech Quality Adjust

Adjust the speech quality.

**Microphone Level** : Adjust the level of microphone gain. Default is "0".

**Echo Cancel Level** : Adjust the level of echo cancellation. Default is "0".

**Noise Reduction Level** : Reduce the noise generated in the surrounding environment without changing the microphone volume. Use this function when the voice of caller is not clear. Default is "0".

#### ■ iPod Bluetooth Connection

See **Select the method of making connections for outputting sound from the iPod source** (P.32).

## Setup

### ■ TV Tuner Control

Sets when connecting the TV tuner to AV-IN input terminal.

To use this function, it is necessary to set "AV-IN" to "None" in **Camera Assignment Settings**. (P.56)

**ON**: Set to ON when connecting the 3rd party TV tuner. AV-IN Name is set to TV. If you connect the TV tuner made by DOS and watch TV, you can perform some simple operations by touching the screen of this unit.

**OFF** (Default): Set to OFF when not connecting the 3rd party TV tuner.

### ■ AV-OUT

You can select an AV source to be output from the AV OUTPUT port.

OFF, AV-IN, USB or iPod

- You cannot select AV-IN if the AV-IN input terminal is used for camera.
- You cannot select iPod if it is connected via Bluetooth.
- If you select USB, iPod, Bluetooth audio, Radio or Digital Radio as the main source, you cannot select USB or iPod as the AV output source.
- If you select Wireless Mirroring, Apple CarPlay or Android Auto as the main source, you cannot select USB or iPod as the AV output source.

### ■ Driving Position

Select the driving position (left or right).

"Left" (Default)/"Right"

### ■ Wi-Fi SETUP (DMX8020DABS)

You can change the device name and display the device address, password. See **Change the device name** (P.64).

### ■ Reset Android Auto Wireless Connection (DMX8020DABS)

You can change the password for wireless Android Auto.

The system of the unit is rebooted after selecting **YES**.

## ■ Change the device name

- 1 Touch **Wi-Fi SETUP** on the AV screen.
- 2 Touch **Device Name**.  
➤ Change Device Name screen appears.
- 3 Touch and hold **BS**.
- 4 Input the device name.

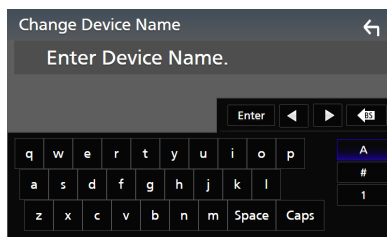

- 5 Touch **Enter**.



# Controlling Audio

You can adjust various settings such as audio balance or subwoofer level.

## 1 Press the **MENU** button.

➤ Pop-up menu appears.

## 2 Touch **Audio**.

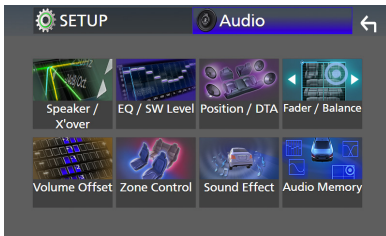

See the following section for each setting.

- Set up Speaker / X'over (**P.66**)
- Controlling EQ / SW Level (**P.68**)
- Set Position / DTA (**P.72**)
- Controlling Fader / Balance (**P.68**)
- Set Volume Offset (**P.69**)
- Performing Zone Control (**P.70**)
- Set Sound Effect (**P.71**)
- Use Audio Memory (**P.73**)

## 3-way speaker system setup

Select the appropriate crossover network mode for the speaker system used (2-way or 3-way speaker system).

## 1 Press the **HOME** button.

➤ HOME screen appears.

## 2 Touch .

➤ Source selection screen appears.

## 3 Touch **STANDBY**.

## 4 Press the button ① followed by the button ② for 1 second at the same time.



➤ Speaker system select screen appears.

## 5 Select the crossover network mode.

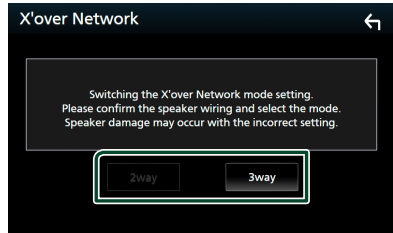

➤ A confirmation screen appears.

## 6 Touch **Yes**.

### NOTE

- When the 3-way speaker system is selected, the following functions are disabled.
  - Front focus of Listening Position / DTA
  - Fader for Controlling General Audio
  - Zone Control
  - Selection of the speakers to output sound from the cell-phone of Bluetooth HF/Audio
  - Beep for User Interface Setup
- Connecting 3-way speakers with the 2-way mode selected can break the speakers.
- When the dual zone is selected and audio source other than "OFF" is selected as Rear Source, the speaker system cannot be switched.

## Speaker / X'over setup

- 1 Press the **MENU** button.  
➤ Pop-up menu appears.
- 2 Touch **Audio**.  
➤ Audio screen appears.
- 3 Touch **Speaker / X'over**.



- 4 Select a car type.

You can select the car type and speaker network, etc.

When you select your car type, the Delay Time Alignment is activated automatically (for timing adjustment of sound output for each channel) to have the highest surround effects.



- 5 Touch the speaker (①) you wish to adjust and set each parameter (②) as follows.

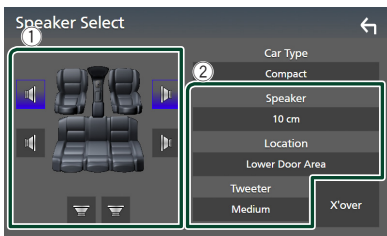

### ■ Speaker

You can select a speaker type and its size to get the best sound effects.

When the speaker type and size are selected, the speaker crossover network is set automatically.

### ■ Location (Only for Front, Rear)

Select the speaker position you have installed.

### ■ Tweeter (Only for Front)

You can set up the tweeter when you are selecting front speakers.

None, Small, Medium, Large

### ■ X'over

Display the speaker crossover setup screen.

You can adjust the crossover frequency that was set automatically when you selected the speaker type.

For details, see **Crossover network setup (P.66)**

### When Speaker network is set to 3-way:

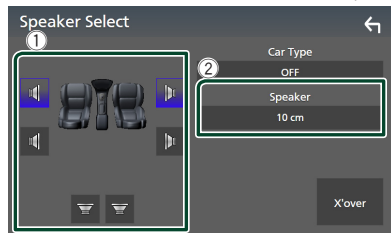

### NOTE

- For how to switch to the 3-way speaker system, see **3-way speaker system setup (P.65)**. Connecting 3-way speakers with the 2-way mode selected can break the speakers.
- Select "None" if you have no speakers.

## Crossover network setup

You can set the crossover frequency of speakers.

- 1 Touch **X'over**.

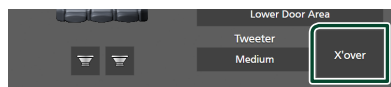

- 2 Touch the speaker to set up.



### 3 Set each parameter as follows.

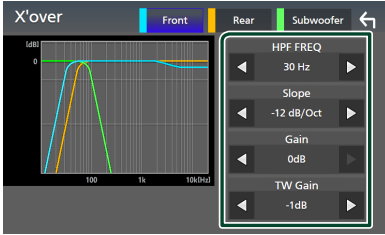

#### ■ HPF FREQ

High Pass Filter adjustment. (When Front or Rear is selected on the Speaker Select screen)

#### ■ LPF FREQ

Low Pass Filter adjustment. (When Subwoofer is selected on the Speaker Select screen)

#### ■ Slope \*1

Set a crossover slope.

#### ■ Gain

Adjust the gain of the front speaker, rear speaker, or subwoofer.

#### ■ TW Gain \*2

Adjust the tweeter level. (When Front is selected on the Speaker Select screen)

#### ■ Phase Inversion \*3

Set the phase of subwoofer output.  
Check **Phase Inversion** to shift the phase 180 degrees. (When Subwoofer is selected on the Speaker Select screen)

\*1 Only when "LPF FREQ"/"HPF FREQ" is set to a mode other than "Through" in **X'over**.

\*2 Only when "Tweeter" is set to "Small", "Medium", "Large" in **Speaker Setup**.

\*3 Only when "Subwoofer" is set to a mode other than "None" in **Speaker Setup**.

### When Speaker network is set to 3-way:

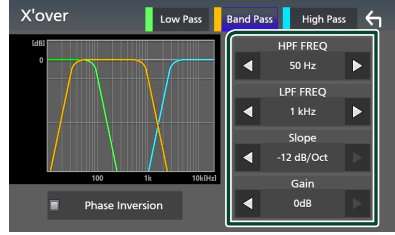

#### ■ FREQ (High Pass)

High Pass Filter adjustment.

#### ■ HPF FREQ, LPF FREQ (Band Pass)

Band Pass Filter adjustment. (When Mid Range Speaker is selected on the Speaker Select screen)

#### ■ FREQ (Low Pass)

Low Pass Filter adjustment. (When Woofer is selected on the Speaker Select screen)

#### ■ Slope \*1 \*2

Set a crossover slope.

#### ■ Gain

Set the gain of each speaker.

#### ■ Phase Inversion

Set the phase of tweeter, mid range, and woofer output.

Check **Phase Inversion** to shift the phase 180 degrees.

\*1 Only when "LPF FREQ"/"HPF FREQ" (Band Pass) is set to a mode other than "Through" in **X'over**.

\*2 Only when "FREQ" (Low Pass) is set to a mode other than "Through" in **X'over**.

#### NOTE

- For how to switch to the 3-way speaker system, see **3-way speaker system setup (P.65)**. Connecting 3-way speakers with the 2-way mode selected can break the speakers.

## Controlling General Audio

- 1 Press the **MENU** button.
  - Popup menu appears.
- 2 Touch **Audio**.
  - Audio screen appears.
- 3 Touch **Fader / Balance**.



- 4 Set each parameter as follows.

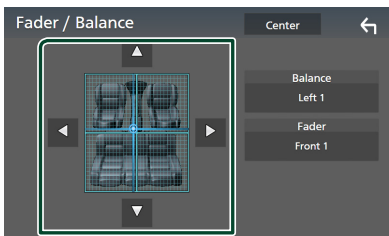

### ■ Fader / Balance

Adjust the volume balance around the touched area.

◀ and ▶ adjust the right and left volume balance.

▲ and ▼ adjust the front and rear volume balance.

### ■ Center

Clear the adjustment.

### NOTE

- When the 3-way speaker system is selected, "Fader" adjustment is disabled.

## Equalizer Control

You can adjust equalizer by selecting the optimized setting for each category.

- 1 Press the **MENU** button.
  - Popup menu appears.
- 2 Touch **Audio**.
  - Audio screen appears.
- 3 Touch **EQ / SW Level**.



- 4 Touch the screen and set the **Graphic Equalizer** as desired.

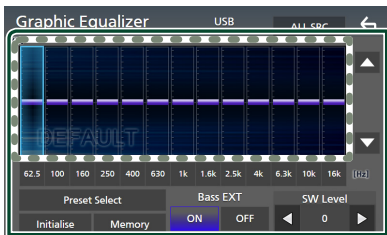

### ■ Gain level (area in dotted frame)

Adjust the gain level by touching each frequency bar.

You can select a frequency bar and adjust its level by ▲, ▼.

### ■ Preset Select

Display the screen for selecting the preset equalizer curve. (P.69)

### ■ Memory

Saves the adjusted equalizer curve as "User1" to "User4". (P.69)

### ■ Initialise

Initialize (flatten) the current EQ curve.

### ■ ALL SRC

Apply the adjusted equalizer curve to all sources. Touch **ALL SRC** and then touch **OK** on the confirmation screen.

### ■ Bass EXT (Bass Extend Settings)

When turned on, the frequencies lower than 62.5 Hz is set to the same gain level (62.5 Hz).

### ■ SW Level

Adjust the subwoofer volume. This setting is not available when Subwoofer is set to "None". See **Speaker / X'over setup (P.66)**.

### ■ Recall the EQ curve

- 1 Touch **Preset Select**.
- 2 Select an EQ curve.

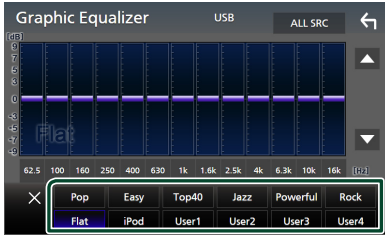

#### NOTE

- **iPod** is available for the iPod and Apple CarPlay sources and it is connected via USB.
- **iPod** is also available for the Apple CarPlay source that is connected wirelessly.

### ■ Save the EQ curve

- 1 Adjust the EQ curve.
- 2 Touch **Memory**.
- 3 Select where to save.

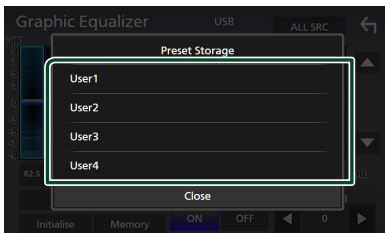

## Volume Offset

Finely adjust the volume of the current source to minimize the difference in volume between different sources.

- 1 Press the **MENU** button.
  - Popup menu appears.
- 2 Touch **Audio**.
  - Audio screen appears.
- 3 Touch **Volume Offset**.

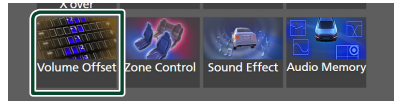

- 4 Touch **+ or -** to adjust the level.

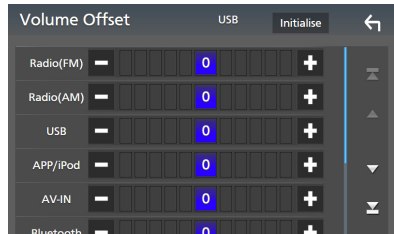

### ■ Initialise

Returns to the initial settings.

#### NOTE

- If you have increased the volume first, then reduce the volume using "Volume Offset". Switching the current source to another source suddenly may output extremely loud sound.

## Zone Control

You can select different sources for front and rear positions in the vehicle.

**1 Press the MENU button.**

- Popup menu appears.

**2 Touch Audio.**

- Audio screen appears.

**3 Touch Zone Control.**

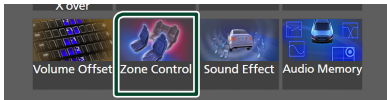

- Zone Control screen appears.

**4 Touch Zone Select.**

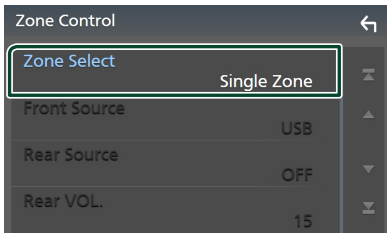

**5 Touch Dual Zone.**

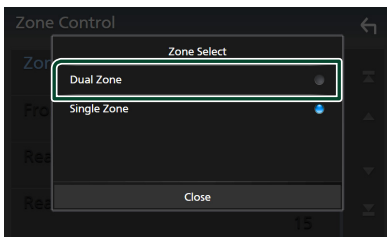

**6 Set each source as follows.**

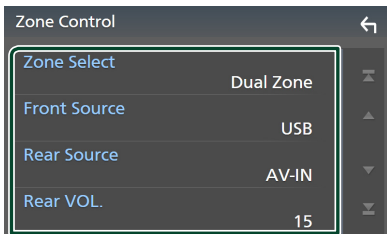

**■ Zone Select**

Touch **Single Zone** to turn off the dual zone function.

**■ Front Source, Rear Source**

Select an audio source for each.  
Rear Source; "AV-IN"/"iPod"/"USB"/"OFF"

**■ Rear VOL.**

Adjust the rear source volume.

### NOTE

- When the rear speaker sound is switched, the audio source that is output at the AV OUTPUT terminal is also switched to the same source.
- When the dual zone function is set to on, the following functions are not available.
  - Output from the subwoofer
  - Subwoofer Level/Bass Boost **(P.71)**
  - Equalizer Control/Sound Effect/Listening Position **(P.68, 71, 72)**
  - Speaker Setup **(P.66)**
  - High-resolution Sound Source File Playback
- You cannot select AV-IN if the AV-IN input terminal is used for camera.
- You cannot select iPod if it is connected via Bluetooth.
- If you select USB, iPod, Bluetooth audio or Radio as the Front Source, you cannot select USB or iPod as the Rear Source.
- If you select Wireless Mirroring, Apple CarPlay or Android Auto as the Front Source, you cannot select USB or iPod as the Rear Source.
- When the dual zone is selected and audio source other than "OFF" is selected as Rear Source, the speaker system cannot be switched.

## Sound Effect

You can set sound effects.

- 1 Press the **MENU** button.
  - ▶ Popup menu appears.
- 2 Touch **Audio**.
  - ▶ Audio screen appears.
- 3 Touch **Sound Effect**.

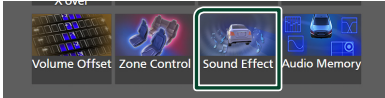

- 4 Set each parameter as follows.

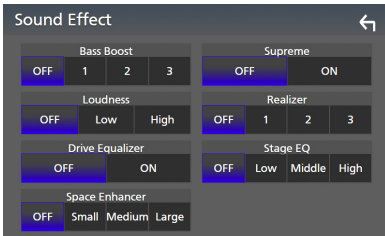

### ■ Bass Boost

Set the amount of bass boost  
"OFF"/"1"/"2"/"3".

### ■ Loudness

Set the amount of boost of low and high tones.  
"OFF", "Low", "High"

### ■ Drive Equalizer

Reduces the driving noise by raising the bandwidth.  
"OFF", "ON"

### ■ Space Enhancer

Select the feeling of sound space enhancement.  
"OFF"/"Small"/"Medium"/"Large".

This setting is not available for the Radio tuner source.

### ■ Supreme

Turn ON/OFF the Supreme function.  
Technology to extrapolate and supplement with proprietary algorithm, the high-frequency range that is cut off when encoding.

### ■ Realizer

Virtually make the sound more realistic using the Digital Signal Processor (DSP) system.  
Select the level from "OFF"/"1"/"2"/"3".

### ■ Stage EQ

You can adjust the height of speakers virtually to suit your listening position.  
"OFF"/"Low"/"Middle"/"High".

## Listening Position / DTA

Listening Position / DTA allows you to improve the sound field depending on the position of the seat you sit.

Listening Position / DTA allows you to set "Listening Position" and "Front Focus". You cannot set both at the same time.

- 1 Press the **MENU** button.
  - Pop up menu appears.
- 2 Touch **Audio**.
  - Audio screen appears.
- 3 Touch **Position / DTA**.



- Set up Listening Position (P.72)
- Set up Front Focus (P.72)

### Listening Position

Adjust the sound delay time so that the sounds from different speakers arrive at the listener sitting on the selected seat at the same time.

- 1 Touch **Listening Position** on the Position / DTA screen.
- 2 Select a listening position from **Front R** (Right front), **Front L** (Left front), **Front All** (All front), and **All**.

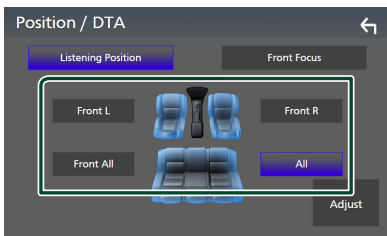

### Position DTA control

You can fine-adjust your listening position.

- 1 Touch **Adjust**.
- 2 Touch **Delay**.

- 3 Touch **◀** or **▶** to adjust the delay time of the selected speaker.



- 4 Touch **Level**.

- 5 Touch **◀** or **▶** to adjust the sound level of the selected speaker.



### NOTE

- To initialize the Delay and Level settings, touch **Initialise** and **YES** on the confirmation screen.

### Front Focus

You can focus the imaginary sound image on the front of the selected seat.

- 1 Touch **Front Focus** in the Position / DTA screen.
- 2 Select a front focus position.

For **Front All** and **All**, select Priority L or R depending on which side you want to put the imaginary sound image.

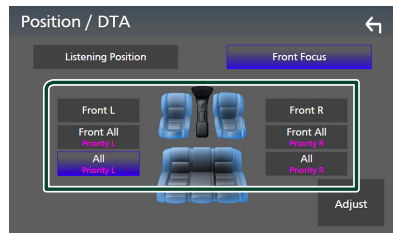



**NOTE**

- When the 3-way speaker system is selected, front focus feature is disabled.

**Front Focus fine adjustment**

- 1 Touch **Adjust**.
- 2 Touch **Delay**.
- 3 Set each parameter as follows.

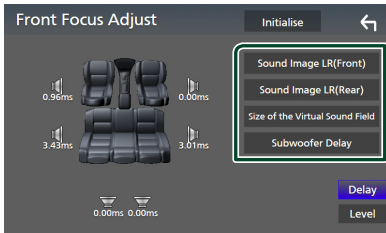
**Sound Image LR (Front)**

Focus the sound image on the front of front seats.

**Sound Image LR (Rear)**

Focus the sound image on the front of rear seats.

**Size of the Virtual Sound Field**

Adjust the size of sound image to meet your taste. If the sound image is shifted from the front, move it back by **Sound Image LR (Front)** or **Sound Image LR (Rear)**.

**Subwoofer Delay**

Adjust the delay time of subwoofer sound.

**4 Touch Level.**

- 5 Touch ◀ or ▶ to adjust the sound level of the selected speaker.

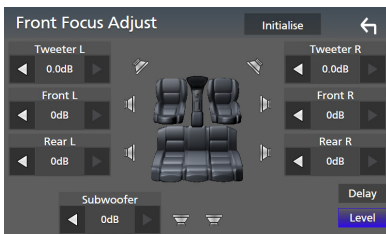
**NOTE**

- To initialize the Delay and Level settings, touch **Initialise** and **YES** on the confirmation screen.

**Audio Setup memory**

Audio Control settings can be memorized. The memorized settings can be recalled at any time.

- 1 Press the **MENU** button.
  - Popup menu appears.
- 2 Touch **Audio**.
  - Audio screen appears.
- 3 Touch **Audio Memory**.

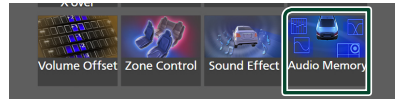
**SETUP Memory**

Lock or unlock the Audio SETUP Memory/Recall/Clear.

**Audio SETUP Memory**

Memorize the current audio settings.

- Fader / Balance, Speaker / X'over, Equalizer (User Preset, SW Level), Position / DTA, Sound Effect (**P.65**)

**Audio SETUP Recall**

Recall the memorized audio setting.

**Audio SETUP Clear**

Clear the Audio SETUP Memory and the currently memorized audio settings.

# Remote control

This unit can be operated using the remote control KNA-RCDV331 (optional accessory).

## ⚠ CAUTION

- Put the remote control in a place where it will not move during braking or other operations. A dangerous situation could result, if the remote control falls down and gets wedged under the pedals while driving.
- Risk of fire or explosion if the battery is replaced by an incorrect type. Ensure to replace only with the same type.
- Risk of fire, explosion or the leakage of flammable liquid or gas if the battery is left in an extremely high temperature surrounding environment and/or subjected extremely low air pressure. The battery pack or batteries shall not be exposed to excessive heat such as sunshine, fire or the like.
- Risk of fire, explosion or the leakage of flammable liquid or gas if the battery is disposed into fire or a hot oven, recharged, shorted, mechanically crushed or cut of the battery.
- If spilled fluid comes in contact with your eyes or on clothing, immediately rinse with water and consult a physician.

## Battery Installation

If the remote control operates only over shorter distances or does not operate at all, it is possible that the batteries are depleted.

In such instances, replace the both batteries with new ones.

- 1 Insert two "AAA"/"R03"-size batteries with the ⊕ and ⊖ poles aligned properly, following the illustration inside the case.

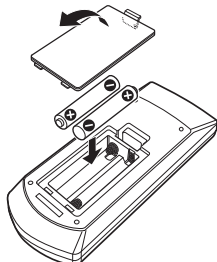

## Functions of the Remote control Buttons

### Switch the operation mode

The functions operated from the remote control differ depending on the position of the mode switch.

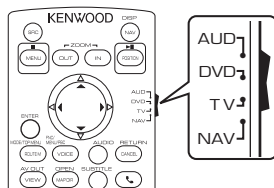

#### ■ AUD mode

Switch to this mode when controlling a selected source or tuner source, etc.

#### ■ DVD mode/TV mode/NAV mode

Not used.

#### NOTE

- When controlling a player that is not integrated in the unit, select "AUD" mode.

### Direct search mode

Using the remote control, you can jump directly to the desired frequency value of the Radio source by entering the number corresponding to the content.

#### NOTE

- This operation cannot be performed for the USB device and iPod.

- 1 Press the #BS button.
- 2 Enter the number of the content you want to play using the numeric keypad.
- 3 Press the ◀ or ▶ button.
  - ▶ The content corresponding to the number you entered is played.

## Basic Operation

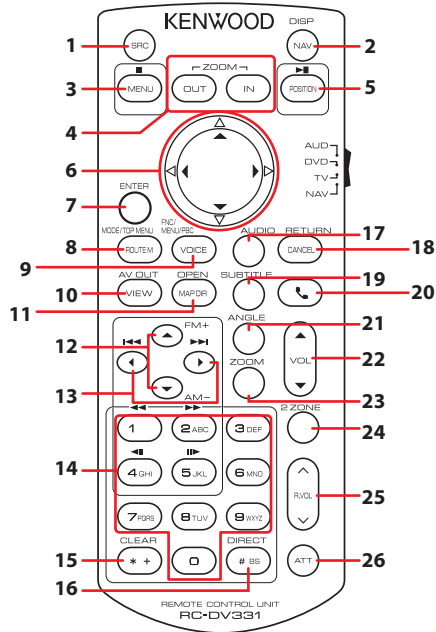

	Key Name	Mode switch	Function
1	SRC	AUD	Switches to the source to be played. In hands-free mode, hangs up the phone.
2	NAV	–	Displays the APP (Apple CarPlay/Android Auto/Wireless Mirroring) screen.
3	MENU	–	Not used.
4	OUT, IN	–	Not used.
5	POSITION	AUD	Pauses the track or file, and resumes playing by pressing twice. For the Radio and Digital Radio sources, switches the seek mode.
6	Cursor Key	–	Not used.
7	ENTER	–	Performs the selected function.
8	ROUTE M	AUD	Screen mode changes each time you press this key during video playback.
9	VOICE	AUD	Displays the control screen of current source. (USB, iPod)
10	VIEW	AUD	Switches the AV source to be output.
11	MAP DIR	AUD	Not used.
12	▲/▼	AUD	Selects the folder to be played. For the Radio source, selects FM/AM band to be received.
13	◀/▶	AUD	Selects the track or file to be played. For the Radio and Digital Radio sources, switches to broadcast stations received by the unit.

## Remote control

	Key Name	Mode switch	Function
14	Numeric Keypad	AUD	For the Radio and Digital Radio sources, allows you to enter the preset number. <ul style="list-style-type: none"> <li>• If the preset number is one digit, press the number.</li> <li>• If the preset number is two digits, press continuously the numbers within 3 seconds.</li> <li>• Pressing ◀▶ within 3 seconds allows you to determine the preset number of one digit.</li> </ul> Allows you to enter the number to search in the direct search mode. For details on the direct search mode, see <b>Direct search mode (P.74)</b> .
15	* +	–	Not used.
16	# BS	AUD	Switches to the direct search mode. For details on the direct search mode, see <b>Direct search mode (P.74)</b> .
17	AUDIO	–	Not used.
18	CANCEL	–	Not used.
19	SUBTITLE	–	Not used.
20		–	When a call comes in, answers the call.
21	ANGLE	–	Not used.
22	Vol ▲▼	–	Adjusts the volume.
23	ZOOM	–	Not used.
24	2 ZONE	AUD	Switches the Dual Zone function on and off.
25	R.VOL ^▼	–	Adjusts volume at rear when the Dual Zone function is on.
26	ATT	–	Lowers the volume when pressed once. Restores the previous volume when pressed twice.

# Connection/Installation

This section is for the professional installer. For safety's sake, leave wiring and mounting to professionals. Consult the car audio dealer.

## Before Installation

Before installation of this unit, please note the following precautions.

### ▲ WARNINGS

- If you connect the ignition wire (red) and the battery wire (yellow) to the car chassis (ground), you may cause a short circuit, that in turn may start a fire. Always connect those wires to the power source running through the fuse box.
- Do not cut out the fuse from the ignition wire (red) and the battery wire (yellow). The power supply must be connected to the wires via the fuse.

### ▲ CAUTION

- Install this unit in the console of your vehicle. Do not touch the metal part of this unit during and shortly after the use of the unit. Metal part such as the heat sink and enclosure become hot.

### NOTE

- Mounting and wiring this product requires skills and experience. For best safety, leave the mounting and wiring work to professionals.
- Make sure to ground the unit to a negative 12V DC power supply.
- Do not install the unit in a spot exposed to direct sunlight or excessive heat or humidity. Also avoid places with too much dust or the possibility of water splashing.
- Do not use your own screws. Use only the screws provided. If you use the wrong screws, you could damage the unit.
- If the power is not turned ON ("There is an error in the speaker wiring. Please check the connections." is displayed), the speaker wire may have a short-circuit or touched the chassis of the vehicle and the protection function may

have been activated. Therefore, the speaker wire should be checked.

- If your car's ignition does not have an ACC position, connect the ignition wires to a power source that can be turned on and off with the ignition key. If you connect the ignition wire to a power source with a constant voltage supply, such as with battery wires, the battery may be drained.
- If the console has a lid, make sure to install the unit so that the front panel will not hit the lid when closing and opening.
- If the fuse blows, first make sure the wires aren't touching to cause a short circuit, then replace the old fuse with one with the same rating.
- Insulate unconnected wires with vinyl tape or other similar material. To prevent a short circuit, do not remove the caps on the ends of the unconnected wires or the terminals.
- Connect the speaker wires correctly to the terminals to which they correspond. The unit may be damaged or fail to work if you share the ⊖ wires or ground them to any metal part in the car.
- When only two speakers are being connected to the system, connect the connectors either to both the front output terminals or to both the rear output terminals (do not mix front and rear). For example, if you connect the ⊕ connector of the left speaker to a front output terminal, do not connect the ⊖ connector to a rear output terminal.
- After the unit is installed, check whether the brake lamps, blinkers, wipers, etc. on the car are working properly.
- Mount the unit so that the mounting angle is 30° or less.
- This unit has the cooling fan to decrease the internal temperature. Do not mount the unit in a place where the cooling fan of the unit is blocked. Blocking these openings will inhibit the cooling of the internal temperature and result in malfunction.

## Connection/Installation

### In case of DMX8020DABS

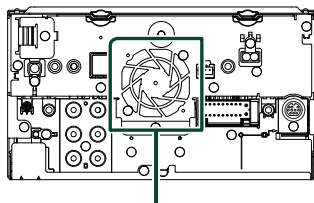



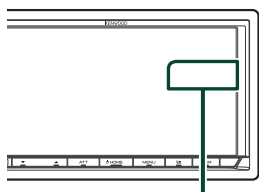

Cooling fan



- Do not press hard on the panel surface when installing the unit to the vehicle. Otherwise scars, damage, or failure may result.
- Reception may drop if there are metal objects near the Bluetooth antenna.

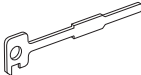
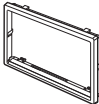

Bluetooth antenna unit

### Supplied accessories for installation

①		x1
②	 (Black 1 m)	x1
③ <sup>[1]</sup>	 (Gray 1 m)	x1
④	 (3 m)	x1
⑤		x2
⑥		x1

⑦	 (3.5 m)	x1
⑧		x1

<sup>[1]</sup> DMX8020DABS only

### Installation procedure

- 1) To prevent a short circuit, remove the key from the ignition and disconnect the  $\ominus$  terminal of the battery.
- 2) Make the proper input and output wire connections for each unit.
- 3) Connect the wire on the wiring harness.
- 4) Take Connector B on the wiring harness and connect it to the speaker connector in your vehicle.
- 5) Take Connector A on the wiring harness and connect it to the external power connector on your vehicle.
- 6) Connect the wiring harness connector to the unit.
- 7) Install the unit in your car.
- 8) Reconnect the  $\ominus$  terminal of the battery.
- 9) Perform the Initial Setup.  
See **Initial SETUP (P.8)**.

### Installing the unit

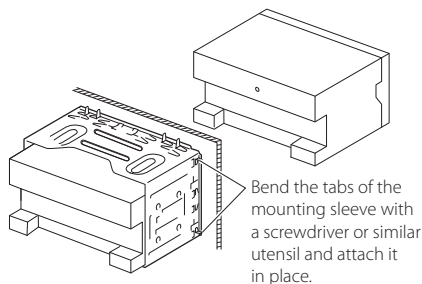

#### NOTE

- Make sure that the unit is installed securely in place. If the unit is unstable, it may malfunction (eg, the sound may skip).

## Trim plate

- 1) Attach accessory ⑥ to the unit.

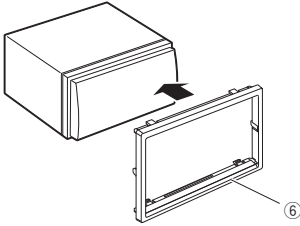

## GPS antenna

GPS antenna is installed inside of the car. It should be installed as horizontally as possible to allow easy reception of the GPS satellite signals.

To mount the GPS antenna inside your vehicle:

- 1) Clean your dashboard or other surface.
- 2) Remove the separator of the metal plate (accessory ⑧).
- 3) Press the metal plate (accessory ⑧) down firmly on your dashboard or other mounting surface. You can bend the metal plate (accessory ⑧) to conform to a curved surface, if necessary.
- 4) Remove the separator of the GPS antenna (accessory ⑦), and stick the antenna to the metal plate (accessory ⑧).

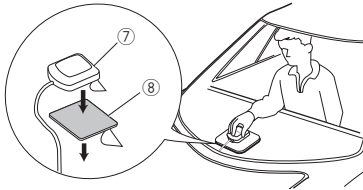

## NOTE

- Use the supplied GPS antenna. Using the GPS antenna other than the supplied one may cause a drop in positioning accuracy.
- Depending on the type of car, reception of the GPS satellite signals might not be possible with an inside installation.
- Please install this GPS antenna in an area away from any antennas that are used with CB radios or satellite televisions.
- The GPS antenna should be installed at a position that is spaced at least 12 inch (30 cm) from cellular phone or other transmitting antennas. Signals from the GPS satellite may be interfered with by these types of communication.
- Painting the GPS antenna with (metallic) paint may cause a drop in performance.

## Microphone unit

- 1) Check the installation position of the microphone (accessory ④).
- 2) Clean the installation surface.
- 3) Remove the separator of the microphone (accessory ④), and stick the microphone to the place shown below.
- 4) Wire the microphone cable up to the unit with it secured at several positions using tape or other desired method.
- 5) Adjust the direction of the microphone (accessory ④) to the driver.

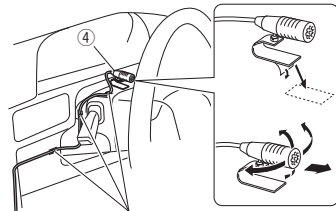

Fix a cable with a commercial item of tape.

### ■ Removing the trim plate

- 1) Engage the catch pins on the extraction key (accessory ⑤) and remove the two locks on the lower level.  
Lower the trim plate (accessory ⑥) and pull it forward as shown in the figure.

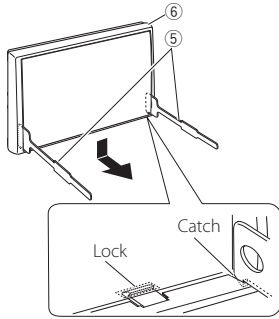

#### NOTE

- The trim plate can be removed from the top side in the same manner.

- 2) When the lower level is removed, remove the upper two locations.

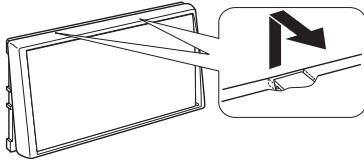

### ■ Removing the unit

- 1) Remove the trim plate. **(P.80)**
- 2) Insert the two extraction keys (accessory ⑤) deeply into the slots on each side, as shown.

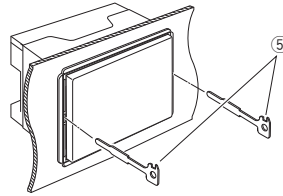

- 3) Lower the extraction key toward the bottom, and pull out the unit halfway while pressing towards the inside.

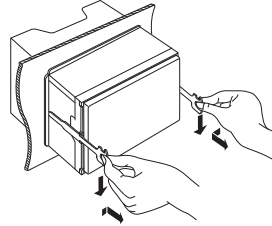

#### NOTE

- Be careful to avoid injury from the catch pins on the extraction key.

- 4) Pull the unit all the way out with your hands, being careful not to drop it.

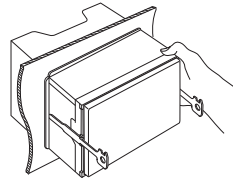



## Connecting wires to terminals

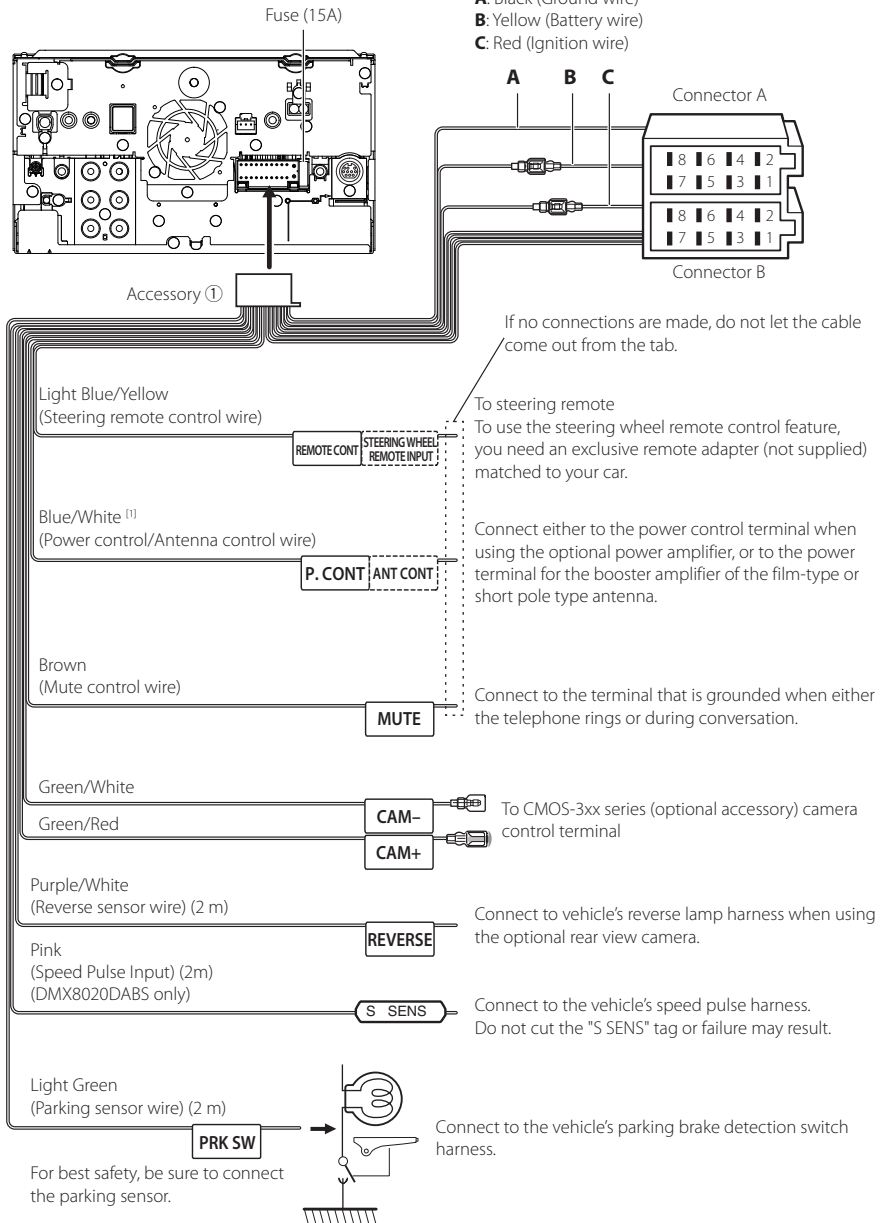

[1] [2]: Blue/White wire is provided two wires, [1] and [2]. Blue/White wire total output ([1] + [2]): 12 V  $\approx$  350 mA

### 3-way speaker system setup

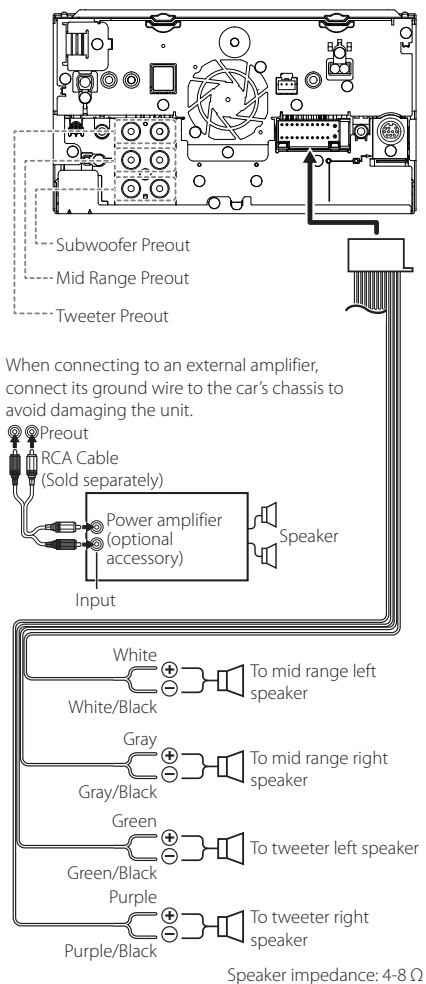

#### NOTE

- For speaker system setup, see **3-way speaker system setup (P.65)**.
- For speaker setup and crossover setup, see **Speaker / X'over setup (P.66)**.
- For how to connect speaker wires to terminals other than speaker terminals and Preout terminals, see **Connecting the system and external components (P.83)** and **Connecting wires to terminals (P.81)**.

### Wiring harness (Accessory ①) connector function guide

Pin	Color and function	
A-4	Yellow	Battery
A-5	Blue/White <sup>[2]</sup>	Power Control
A-6	Orange/White	Dimmer
A-7	Red	Ignition (ACC)
A-8	Black	Earth (Ground) Connection
B-1/B-2	Purple (+) / Purple/Black (-)	Rear Right
B-3/B-4	Gray (+) / Gray/Black (-)	Front Right
B-5/B-6	White (+) / White/Black (-)	Front Left
B-7/B-8	Green (+) / Green/Black (-)	Rear Left

\*Speaker Impedance: 4-8 Ω

[1] [2]: Blue/White wire is provided two wires, [1] and [2].

Blue/White wire total output ([1] + [2]):

12 V  $\approx$  350 mA

### ⚠ WARNING for Connecting the ISO Connector

The pin arrangement for the ISO connectors depends on the type of vehicle you drive. Make sure to make the proper connections to prevent damage to the unit. The default connection for the wiring harness is described in (1) below. If the ISO connector pins are set as described in (2), make the connection as illustrated. Please be sure to reconnect the cable as shown (2) below to install this unit to the Volkswagen vehicles etc.

#### (1): Default setting

The red (A-7 pin) of the vehicle's ISO connector is linked with the ignition, and the yellow (A-4 pin) is connected to the constant power supply.

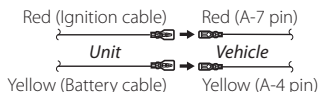

#### (2)

The red (A-7 pin) of the vehicle's ISO connector is connected to the constant power supply, and the yellow (A-4 pin) is linked to the ignition.

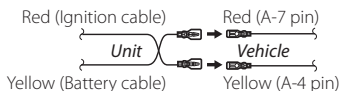

## Connecting the system and external components

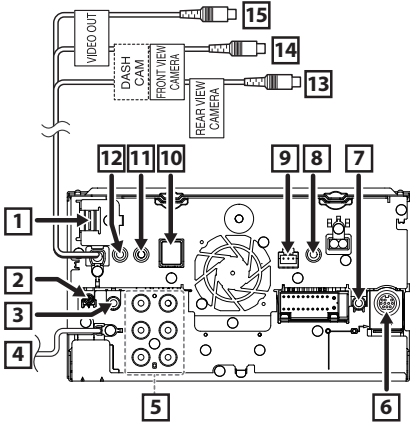

**1** HDMI input  
Use HDMI cable KCA-HD100 (optional accessory).  
When you connect the cable to HDMI terminal, remove the fixture. After connecting the cable, put the fixture again.

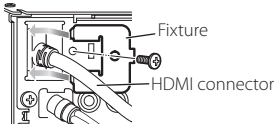

**2** Digital Radio antenna CX-DAB1 (Optional accessory)  
⚠ Use of a CX-DAB1 (optional accessory) as a Digital Radio antenna is recommended. When using a commercially available Digital Radio antenna, the diameter of the SMB connector must be  $\Phi 6.5$  mm or less.

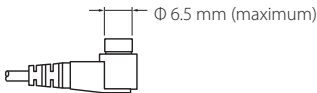

**3** AV Audio output ( $\phi 3.5$  mini jack)

**4** FM/AM antenna input

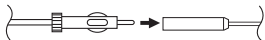

**5** When connecting to an external amplifier, connect its ground wire to the car's chassis to avoid damaging the unit.

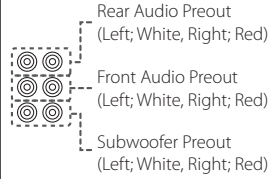

**6** External I/F (DMX8020DABS only)  
Maximum power supply current : 12 V  $\approx$  500 mA

**7** TV tuner remote output

**8** This jack accepts either AV-IN (CA-C3AV; optional accessory) or camera input. For more information, see **To set up the camera assignment settings (P.56)**.

**9** Dashboard camera interface  
Connect a Dashboard Camera DRV-N520 (optional accessory). (**P.86**)

**10** Accessory ⑦: GPS Antenna  
Use the supplied GPS antenna. Using the GPS antenna other than the supplied one may cause a drop in positioning accuracy.

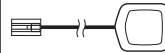

**11** Accessory ④: Bluetooth Microphone

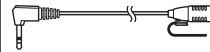

**12** Connect to vehicle's steering remote harness. Contact your KENWOOD dealer for details.

**13** Rear view camera input (Yellow)

**14** Front view camera/Dashboard camera input (Yellow). See **To set up the camera assignment settings (P.56)**.

**15** Visual Output (Yellow)

## Securing the USB extension cable

Secure the USB extension cable with insulating tape or the like so that its connectors are not disconnected.

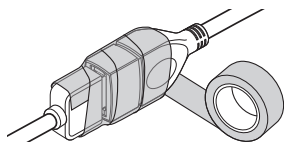

## Connecting a USB device

### DMX8020DABS

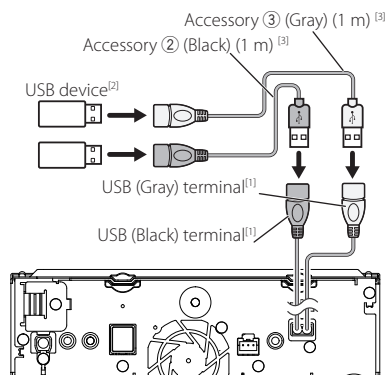

### DMX7520DABS

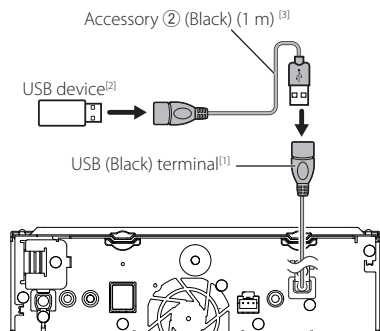

<sup>[1]</sup> USB maximum power supply current :  
 DC 5V  $\approx$  1.5 A

<sup>[2]</sup> Sold separately

<sup>[3]</sup> See **Securing the USB extension cable**  
 (P.84).

## Connecting an iPod/iPhone

### DMX8020DABS

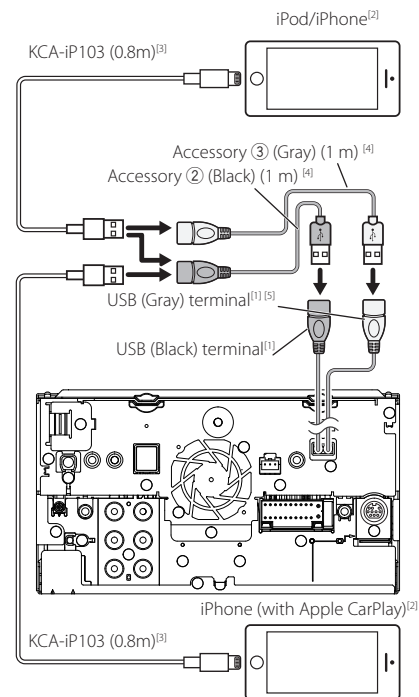

● **DMX7520DABS**

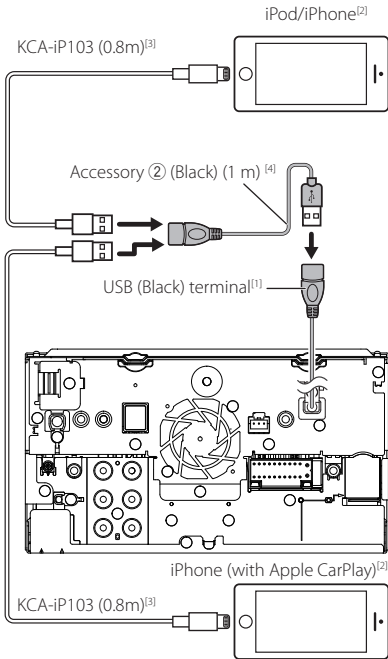

[1] USB maximum power supply current :  
DC 5 V  $\pm$  1.5 A

[2] Sold separately

[3] Optional accessory

[4] See **Securing the USB extension cable (P.84)**.

[5] USB (Gray) terminal does not support USB Mirroring.

■ **Connecting an Android smartphone**

● **DMX8020DABS**

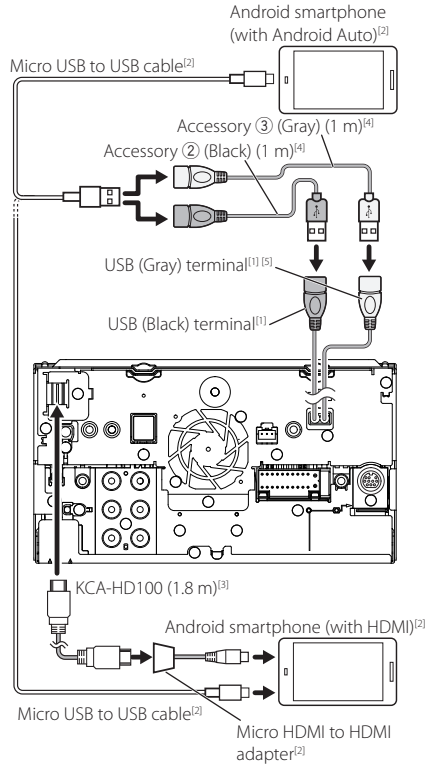

## Connection/Installation

### ● DMX7520DABS

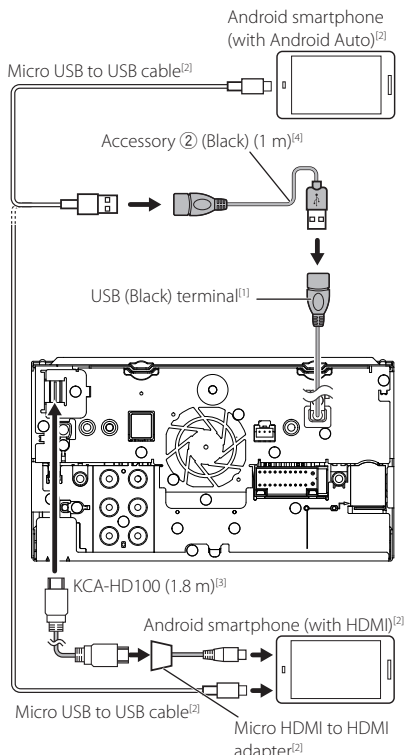

<sup>[1]</sup> USB maximum power supply current :  
DC 5 V  $\overline{\text{---}}$  1.5 A

<sup>[2]</sup> Sold separately

<sup>[3]</sup> Optional accessory

<sup>[4]</sup> See **Securing the USB extension cable (P.84)**.

<sup>[5]</sup> USB (Gray) terminal does not support USB Mirroring.

### ■ Connecting the camera

Left side view camera and  
Right side view camera<sup>[2]</sup>

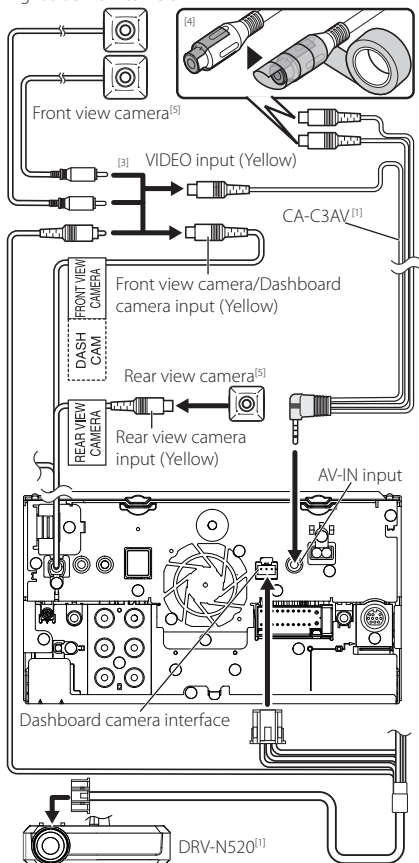

<sup>[1]</sup> Optional accessory

<sup>[2]</sup> Sold separately

<sup>[3]</sup> Up to 2 cameras of Dashboard camera, Front view camera, Left side view camera and Right side view camera can be connected. For details, see **To set up the camera assignment settings (P.56)**.

<sup>[4]</sup> Insulate audio input terminals of CA-C3AV (optional accessory) when connecting to the Camera.

<sup>[5]</sup> CMOS-3xx series (optional accessory) or commercially available camera.

# Troubleshooting

## Problems and Solutions

If any trouble occurs, first check the following table for possible problems.

### NOTE

- Some functions of this unit may be disabled by some settings made on this unit.
- What might seem to be a malfunction in your unit may just be the result of slight misoperation or miswiring.

### About settings

- **Cannot set up the subwoofer.**
- **Cannot set up subwoofer phase.**
- **No output from the subwoofer.**
- **Cannot set up the low pass filter.**
- **Cannot set up the high pass filter.**

Subwoofer is not set to on.

- Set the subwoofer to on. See **Speaker / X'over setup (P.66)**.

The dual zone function is enabled.

- Set the dual zone function to off. See **Zone Control (P.70)**.

- **Cannot select the output destination of the subsource in the dual zone.**
- **Cannot adjust the volume of the rear speakers.**

The dual zone function is disabled.

- Set the dual zone function to on. See **Zone Control (P.70)**.

- **Cannot set up the equalizer.**
- **Cannot set up the crossover network.**

The dual zone function is enabled.

- Set the dual zone function to off. See **Zone Control (P.70)**.

### About audio operations

#### Radio reception is poor.

The car antenna is not extended.

- Pull out the antenna all the way.

The antenna control wire is not connected.

- Connect the wire correctly. See **Connecting the system and external components (P.83)**.

#### Cannot select a folder.

The random play function is enabled.

- Turn off the random function.

#### No sound while using Mirroring for KENWOOD application.

- Make sure the smartphone and the unit is connected via Bluetooth and connected over A2DP/SPP. **(P.21)**
  - Raise the volume on your smartphone.
- Some application does not support Mirroring for KENWOOD application playback. (Apple Music App does not support playback using Mirroring for KENWOOD application.)
- Try another music application.

#### No sound while using "iPod" source or "Bluetooth" source.

- Make sure you stop broadcast on iPhone's screen recording function after you disconnect from mirroring operations.

#### Cannot operate Mirroring for KENWOOD application with touch panel operation.

Available functions may differ from the ones operated on the smartphone.

Depending on the connected smartphone, some functions do not work on this unit.

Depending on the operating system (OS) of the connected smartphone, some functions do not work on this unit.

- Change the smartphone to compatible device. See **USB Mirroring Operation (P.21)**.

#### The unit does not respond when you try to perform a operation during USB mirroring.

- Unplug the smartphone from the USB (Black) terminal, then reattach the smartphone again.

### Others

#### The Touch Sensor Tone doesn't sound.

The preout jack is being used.

- The Touch Sensor Tone cannot be output from the preout jack.

### Error Messages

When you fail to operate the unit correctly, the cause of the failure appears as the message on the screen.

---

#### **There is an error in the speaker wiring. Please check the connections.**

Protective circuit has been activated because a speaker cord has shorted or it has come in contact with the car chassis.

- Wire or insulate the speaker cord as appropriate and turn the power off and on again.

---

#### **Hot Error**

When the internal temperature of this unit rises to 60°C or more, the protection circuit is activated and you may not be able to operate the unit.

- Use the unit again after reducing the temperature of the unit.

---

#### **Error 07–67**

The unit is not operating correctly due to some reason or other.

- Turn the power off and on again. If the “Error 07–67” message does not disappear, contact your nearest KENWOOD dealer.

---

#### **No Device (USB device)**

The USB device is selected as a source although no USB device is connected.

- Change the source to any source other than USB/iPod. Connect a USB device, and change the source to USB again.

---

#### **Disconnected (iPod, Bluetooth audio player)**

The iPod/Bluetooth audio player is selected as a source although no iPod/Bluetooth audio player is connected.

- Change the source to any source other than iPod/Bluetooth. Connect an iPod/Bluetooth audio player, and change the source to iPod/Bluetooth again.

---

#### **No Media file**

The connected USB device contains no playable audio file. Media was played that doesn't have data recorded that the unit can play.

- See **Playable Media and Files (P.89)** and try another USB device.

The USB device which contains no playable audio file is selected. (DMX8020DABS)

- Switch USB devices. See **USB DEVICE CHANGE (P.30)**.

---

#### **USB device over current status detected.**

The connected USB device is rated a current capacity higher than the allowable limit.

- Check the USB device. Some trouble may have occurred to the connected USB device.
- Change the source to any source other than USB. Remove the USB device.

---

### Apple CarPlay

---

#### **The GPS antenna must be connected to use Apple CarPlay wirelessly. Please verify the proper connections or plug in by USB to use Apple CarPlay.**

The GPS antenna is not connected when the Apple CarPlay is started by connecting wirelessly or when the iPhone compatible with wireless Apple CarPlay is registered in **Apple CarPlay Device List**.

- Check the connection of the GPS antenna or plug in over USB to use Apple CarPlay.

---

#### **The speed sensor and the GPS antenna must be connected to use Apple CarPlay wirelessly. Please verify the proper connections or plug in by USB to use Apple CarPlay.**

The speed pulse is not detected and the GPS antenna is not connected when the Apple CarPlay is started by connecting wirelessly or when the iPhone compatible with wireless Apple CarPlay is registered in **Apple CarPlay Device List**.

- Check the connection of the speed pulse and the GPS antenna or plug in over USB to use Apple CarPlay.



# Appendix

## Playable Media and Files

You can play various kinds of media and files on this unit.

### About files

The following audio and video files are supported.

#### ■ Playable Audio files

	Format	Bit rate	Sampling frequency	Bit count
AAC-LC (.m4a)	MPEG-2/MPEG-4 AAC LC HE-AAC(V1,V2)	8 – 320kbps, VBR	16 – 48 kHz	16 bit
MP3 (.mp3)	MPEG-1/MPEG-2 Audio Layer 3	8 – 320kbps, VBR	16 – 48 kHz	16 bit
WMA (.wma)	Windows Media Audio Standard L3 profile (Version 7,8,9)	8 – 320kbps	16 – 48 kHz	16 bit
Linear PCM (WAVE) (.wav)	RIFF waveform Audio Format	–	16 – 192 kHz	16 bit/24 bit
FLAC (.flac)	flac	–	16 – 192 kHz	16 bit/24 bit
Vorbis (.ogg)	vorbis	–	16 – 48 kHz	16 bit

- WMA and AAC files with DRM cannot be played.
- Although the audio files complies with the standards listed above, they may not be played depending on the types or conditions of media or device.
- This unit supports playback of High-Resolution Audio files.  
It is recommended that a car audio system should be configured with all High-Resolution Audio compatible products from player to speaker to enjoy its high quality sound.

#### ■ Acceptable Video files

	Profile	Max. Picture size	Max. bit rate	Audio format
MPEG-1 (.mpg, .mpeg)	–	352 × 240, 352 × 288	1.5 Mbps	MPEG Audio Layer 2
MPEG-2 (.mpg, .mpeg)	MP@ML	720 × 480, 720 × 576	8 Mbps	MPEG Audio Layer 2
H.264/MPEG-4 AVC (.mp4, .m4v, .avi, .flv, .f4v)	Baseline Profile, Main Profile	1920 × 1080 (30 fps)	8 Mbps	MP3, AAC
MPEG-4 (.mp4, .avi)	Advanced Simple Profile	1920 × 1080 (30 fps)	8 Mbps	MP3, AAC
WMV (.wmv)	Main Profile	1920 × 1080 (30 fps)	8 Mbps	WMA
MKV (.mkv)	Video format follows H.264/MPEG-4 AVC, MPEG-4, WMV			MP3, AAC, WMA, Vorbis, FLAC

- This unit can only play back files which are smaller than 4 GB.

#### ■ Limitation on structure of file and folder

	USB device
Maximum number of folder layers	8
Maximum number of files (per folder)	999
Maximum number of folders (per folder)	9999
Maximum number of folders (per device)	Unlimited

- You can enter a folder name and file name with 255 or fewer single-byte characters.
- Files in the folder whose folder name begins with a dot (.) cannot be played.

## Specifications

### ■ Monitor section

#### Picture Size

- : 6.95 inches (diagonal) wide
- : 156.6 mm (W) × 81.6 mm (H)
- 6-3/16 × 3-3/16 inch

#### Display System

- : TN LCD panel

#### Drive System

- : TFT active matrix system

#### Number of Pixels

- : 1,152,000 (800H x 480V x RGB)

#### Effective Pixels

- : 99.99 %

#### Pixel Arrangement

- : RGB striped arrangement

#### Back Lighting

- : LED

### ■ USB interface section

#### USB Standard

- : USB 2.0 High Speed

#### File System

- : FAT16, FAT32, exFAT, NTFS

#### Maximum Power Supply Current

- : DC 5 V  1.5 A × 2

#### D/A Converter

- : 24 bit/32 bit

#### Audio Decoder

- : MP3 / WMA / AAC / WAV / FLAC / Vorbis

#### Video Decoder

- : MPEG-1 / MPEG-2 / MPEG-4 / WMV / H.264 / MKV

#### Frequency Response

- 192 kHz : 20 – 88,000 Hz
- 96 kHz : 20 – 44,000 Hz
- 48 kHz : 20 – 22,000 Hz
- 44.1 kHz : 20 – 20,000 Hz

#### Total Harmonic Distortion

- : 0.010 % (1 kHz)

#### S/N Ratio (dB)

- : 98.5 dB

#### Dynamic Range

- : 89 dB

### ■ Wireless Mirroring section (DMX8020DABS)

#### Mode

- : Sink

#### Copyright protection

- : HDCP2.2

#### Touch Control

- : UIBC

### ■ Wi-Fi section (DMX8020DABS)

#### IEEE Standard

- : 802.11 a/b/g/n/ac

#### Frequency Range

- : Dual Band (2.4GHz/5GHz)

#### Channels

- : Auto (1-11ch)/Auto (149,153,157,161ch)

#### Transfer rates (MAX)

- : 11a: 54 Mbps / 11b: 11 Mbps / 11g: 54 Mbps /  
11n: 300 Mbps / 11ac: 867 Mbps

#### Output Power

##### 2.4 GHz/SISO

- : 11b: 14 dBm ± 2 dB / 11g: 13 dBm ± 2 dB /  
11n (20 MHz): 12 dBm ± 2 dB

##### 5 GHz/SISO

- : 11a: 9 dBm ± 2 dB /  
11n (20 MHz)/11ac (20 MHz): 9 dBm ± 2 dB /  
11n (40 MHz)/11ac (40 MHz): 8 dBm ± 2 dB /  
11ac (80 MHz): 8 dBm ± 2 dB

##### 5 GHz/MIMO

- : 11n (20 MHz)/11ac (20 MHz): 11 dBm ± 2 dB /  
11n (40 MHz)/11ac (40 MHz): 11 dBm ± 2 dB /  
11ac (80 MHz): 11 dBm ± 2 dB

### ■ Bluetooth section

#### Technology

- : Bluetooth Ver.5.0

#### Frequency

- : 2.402 – 2.480 GHz

#### Output Power

- : +4dBm (MAX), Power Class2

#### Maximum Communication range

- : Line of sight approx. 10m (32.8 ft)

#### Audio Codec

- : SBC/AAC

#### Profile (Multi Profile support)

- HFP (V1.7) (Hands Free Profile)
- SPP (Serial Port Profile)
- A2DP (Advanced Audio Distribution Profile)
- AVRCP (V1.6) (Audio/Video Remote Control Profile)
- PBAP (Phonebook Access Profile)

### ■ HDMI section

#### HDMI

- : Type-A

#### Input Resolution

- VGA (640x480p @59.94Hz/60Hz)
- 480p (720x480p @59.94Hz/60Hz)
- 720p (1280x720p @59.94Hz/60Hz)

#### Input Audio Type

- : 32K/44.1K/48K/88.2K/96K/176.2K/192K Hz  
16 bit/20 bit/24 bit Linear PCM

## ■ Digital Radio section

### Frequency Range

BAND III: 174.928 – 239.200 (MHz)

### Sensitivity

: -100 dBm

### S/N Ratio (dB)

: 90 dB

## ■ Digital Antenna Connector section

### Connector type

: SMB

### Output Voltage (11 – 16V)

: 14.4 V

### Maximum Current

: < 100 mA

## ■ DSP section

### Graphics equalizer

Band: 13 Band

Frequency (BAND1 – 13)

: 62.5/100/160/250/400/630/1k/1.6k/2.5k/4k/6.3k/  
10k/16k Hz

### Gain

: -9/-8/-7/-6/-5/-4/-3/-2/-1/0/1/2/3/4/5/6/7/8/9 dB

### 2-way X'Over

#### High pass filter

Frequency: Through, 30/40/50/60/70/80/90/100/  
120/150/180/220/250 Hz

Slope: -6/-12/-18/-24 dB/Oct.

#### Low pass filter

Frequency: 30/40/50/60/70/80/90/100/120/150/  
180/220/250 Hz, Through

Slope: -6/-12/-18/-24 dB/Oct.

### 3-way X'Over

#### High pass filter

Frequency: 250/300/1k/1.6k/2.5k/4k/5k/6.3k/8k/  
10k/12.5k Hz

Slope: -12/-18/-24 dB/Oct.

#### Band pass filter

Frequency: Through, 50/60/70/80/90/100/120/150/  
180/220/250/300 Hz  
250/300/1k/1.6k/2.5k/4k/5k/6.3k/8k Hz,  
Through

Slope: -12/-18/-24 dB/Oct.

#### Low pass filter

Frequency: 30/40/50/60/70/80/90/100/120/150 Hz,  
Through

Slope: -12/-18/-24 dB/Oct.

### Position

#### Front / Rear /Subwoofer Delay

: 0 – 6.1 m (0.01 m Step)

#### Gain

: -8 – 0 dB

### Subwoofer level

: -50 – +10 dB

## ■ FM tuner section

### Frequency Range (step)

: 87.5 MHz – 108.0 MHz (50 kHz)

### Usable Sensitivity (S/N : 30 dB)

: 9.3 dBf (0.8  $\mu$ V/75  $\Omega$ )

### Quieting Sensitivity (S/N : 46 dB)

: 15.2 dBf (1.6  $\mu$ V/75  $\Omega$ )

### Frequency Response

: 30 Hz – 15 kHz

### S/N Ratio (dB)

: 65 dB (MONO)

### Selectivity ( $\pm$ 400 kHz)

: Over 80 dB

### Stereo Separation

: 45 dB (1 kHz)

## ■ AM tuner section

### Frequency Range (step)

LW: 153 – 279 kHz (9 kHz)

MW: 531 – 1611 kHz (9 kHz)

### Usable Sensitivity

MW: 25 $\mu$ V

LW: 45 $\mu$ V

## ■ Video section

### Color System of External Video Input

: NTSC/PAL

### External Video Input Level (mini jack)

: 1 V<sub>p-p</sub>/75  $\Omega$

### External Audio Max Input Level (mini jack)

: 2 V/25 k $\Omega$

### Video Input Level (RCA jacks)

: 1 V<sub>p-p</sub>/75  $\Omega$

### Video Output Level (RCA jacks)

: 1 V<sub>p-p</sub>/75  $\Omega$

### Audio Output Level (mini jack)

: 0.9 V/10 k $\Omega$

## ■ Audio section

### Maximum Power (Front & Rear)

: 50 W  $\times$  4

### Typical Power Output (Front & Rear)

Full Bandwidth Power (at less than 1% THD)

: 22 W  $\times$  4

### Output frequency band

: 20 – 88,000 Hz

### Preout Level (V)

: 5 V/10 k $\Omega$

### Preout Impedance

:  $\leq$  300  $\Omega$

### Speaker Impedance

: 4 – 8  $\Omega$

## Appendix

### ■ General

**Operating Voltage**

: 12 V DC car battery

**Installation Dimensions (W × H × D)**

: 178 × 100 × 155 mm

**With Sleeve**

: 182 × 112 × 153 mm

**Weight**

: 1.7 kg

#### NOTE

- Although the effective pixels for the liquid crystal panel is given as 99.99% or more, 0.01% of pixels may not light or may light incorrectly.

**Specifications are subject to change without prior notice.**

## About this Unit

### ■ Copyrights

- The Bluetooth® word mark and logos are registered trademarks owned by Bluetooth SIG, Inc. and any use of such marks by JVCKENWOOD Corporation is under license. Other trademarks and trade names are those of their respective owners.
- The product with the Hi-Res Audio logo is conformed to Hi-Res Audio standard defined by Japan Audio Society. The logo is used under license from Japan Audio Society.



- Windows Media is a registered trademark or trademark of Microsoft Corporation in the United States and/or other countries. This product is protected by certain intellectual property rights of Microsoft. Use or distribution of such technology outside of this product is prohibited without a license from Microsoft.
- This software is based in part on the work of the independent JPEG Group.
- Use of the Made for Apple badge means that an accessory has been designed to connect specifically to the Apple product(s) identified in the badge, and has been certified by the developer to meet Apple performance standards. Apple is not responsible for the operation of this device or its compliance with safety and regulatory standards. Please note that the use of this accessory with an Apple product may affect wireless performance.
- Apple, iPhone, iPod, iPod touch, and Lightning are trademarks of Apple Inc., registered in the U.S. and other countries.
- Apple, Siri, Apple CarPlay, Apple Music and Apple CarPlay logo are trademarks of Apple Inc., registered in the U.S. and other countries.
- iOS is a trademark or registered trademark of Cisco in the U.S. and other countries and is used under license.
- Google, Android, Google Play and Android Auto are trademarks of Google LLC.
- To use Android Auto on your car display, you'll need an Android Auto compatible vehicle or aftermarket stereo, an Android phone running Android 5.0 or higher, and the Android Auto app.
- Wi-Fi® is a registered trademark of Wi-Fi Alliance®.
- The Wi-Fi CERTIFIED™ Logo is a certification mark of Wi-Fi Alliance®.
- Linux® is the registered trademark of Linus Torvalds in the U.S. and other countries.

- The terms HDMI and HDMI High-Definition Multimedia Interface, and the HDMI Logo are trademarks or registered trademarks of HDMI Licensing Administrator, Inc. in the United States and other countries.
- This product includes FontAvenue® fonts licenced by NEC Corporation. FontAvenue is a registered trademark of NEC Corporation.



- This product includes "Ubiquitous QuickBoot TM" technology developed by Ubiquitous Corp. Ubiquitous QuickBoot TM is a trademark of Ubiquitous Corp. Copyright© 2017 Ubiquitous Corp. All rights reserved.



- THIS PRODUCT IS LICENSED UNDER THE AVC PATENT PORTFOLIO LICENSE FOR THE PERSONAL USE OF A CONSUMER OR OTHER USES IN WHICH IT DOES NOT RECEIVE REMUNERATION TO (i) ENCODE VIDEO IN COMPLIANCE WITH THE AVC STANDARD ("AVC VIDEO") AND/OR (ii) DECODE AVC VIDEO THAT WAS ENCODED BY A CONSUMER ENGAGED IN A PERSONAL ACTIVITY AND/OR WAS OBTAINED FROM A VIDEO PROVIDER LICENSED TO PROVIDE AVC VIDEO. NO LICENSE IS GRANTED OR SHALL BE IMPLIED FOR ANY OTHER USE. ADDITIONAL INFORMATION MAY BE OBTAINED FROM MPEG LA, L.L.C. SEE <HTTPS://WWW.MPEGLA.COM>
- THIS PRODUCT IS LICENSED UNDER THE MPEG-4 VISUAL PATENT PORTFOLIO LICENSE FOR THE PERSONAL AND NON-COMMERCIAL USE OF A CONSUMER FOR (i) ENCODING VIDEO IN COMPLIANCE WITH THE MPEG-4 VISUAL STANDARD ("MPEG-4 VIDEO") AND/OR (ii) DECODING MPEG-4 VIDEO THAT WAS ENCODED BY A CONSUMER ENGAGED IN A PERSONAL AND NON-COMMERCIAL ACTIVITY AND/OR WAS OBTAINED FROM A VIDEO PROVIDER LICENSED BY MPEG LA TO PROVIDE MPEG-4 VIDEO. NO LICENSE IS GRANTED OR SHALL BE IMPLIED FOR ANY OTHER USE. ADDITIONAL INFORMATION INCLUDING THAT RELATING TO PROMOTIONAL, INTERNAL AND COMMERCIAL USES AND LICENSING MAY BE OBTAINED FROM MPEG LA, LLC. SEE <HTTPS://WWW.MPEGLA.COM>
- THIS PRODUCT IS LICENSED UNDER THE VC-1 PATENT PORTFOLIO LICENSE FOR THE PERSONAL AND NON-COMMERCIAL USE OF A CONSUMER TO (i) ENCODE VIDEO IN COMPLIANCE WITH THE VC-1 STANDARD ("VC-1 VIDEO") AND/OR (ii) DECODE VC-1 VIDEO THAT WAS ENCODED BY A CONSUMER ENGAGED IN A PERSONAL AND NON-COMMERCIAL ACTIVITY AND/OR WAS OBTAINED FROM A VIDEO PROVIDER LICENSED TO PROVIDE VC-1 VIDEO. NO LICENSE IS GRANTED OR SHALL BE IMPLIED FOR ANY OTHER USE. ADDITIONAL INFORMATION MAY BE OBTAINED FROM MPEG LA, L.L.C. SEE <HTTPS://WWW.MPEGLA.COM>

## Appendix

- libFLAC

Copyright (C) 2000-2009 Josh Coalson  
Copyright (C) 2011-2013 Xiph.Org Foundation  
Redistribution and use in source and binary forms, with or without modification, are permitted provided that the following conditions are met:

- Redistributions of source code must retain the above copyright notice, this list of conditions and the following disclaimer.
- Redistributions in binary form must reproduce the above copyright notice, this list of conditions and the following disclaimer in the documentation and/or other materials provided with the distribution.
- Neither the name of the Xiph.org Foundation nor the names of its contributors may be used to endorse or promote products derived from this software without specific prior written permission.

THIS SOFTWARE IS PROVIDED BY THE COPYRIGHT HOLDERS AND CONTRIBUTORS "AS IS" AND ANY EXPRESS OR IMPLIED WARRANTIES, INCLUDING, BUT NOT LIMITED TO, THE IMPLIED WARRANTIES OF MERCHANTABILITY AND FITNESS FOR A PARTICULAR PURPOSE ARE DISCLAIMED. IN NO EVENT SHALL THE FOUNDATION OR CONTRIBUTORS BE LIABLE FOR ANY DIRECT, INDIRECT, INCIDENTAL, SPECIAL, EXEMPLARY, OR CONSEQUENTIAL DAMAGES (INCLUDING, BUT NOT LIMITED TO, PROCUREMENT OF SUBSTITUTE GOODS OR SERVICES; LOSS OF USE, DATA, OR PROFITS; OR BUSINESS INTERRUPTION) HOWEVER CAUSED AND ON ANY THEORY OF LIABILITY, WHETHER IN CONTRACT, STRICT LIABILITY, OR TORT (INCLUDING NEGLIGENCE OR OTHERWISE) ARISING IN ANY WAY OUT OF THE USE OF THIS SOFTWARE, EVEN IF ADVISED OF THE POSSIBILITY OF SUCH DAMAGE.

- libvorbis

Copyright (c) 2002-2008 Xiph.org Foundation  
Redistribution and use in source and binary forms, with or without modification, are permitted provided that the following conditions are met:

- Redistributions of source code must retain the above copyright notice, this list of conditions and the following disclaimer.
- Redistributions in binary form must reproduce the above copyright notice, this list of conditions and the following disclaimer in the documentation and/or other materials provided with the distribution.
- Neither the name of the Xiph.org Foundation nor the names of its contributors may be used to endorse or promote products derived from this software without specific prior written permission.

THIS SOFTWARE IS PROVIDED BY THE COPYRIGHT HOLDERS AND CONTRIBUTORS "AS IS" AND ANY EXPRESS OR IMPLIED WARRANTIES, INCLUDING, BUT NOT LIMITED TO, THE IMPLIED WARRANTIES OF MERCHANTABILITY AND FITNESS FOR A PARTICULAR PURPOSE ARE DISCLAIMED. IN NO EVENT SHALL THE FOUNDATION OR CONTRIBUTORS BE LIABLE FOR ANY

DIRECT, INDIRECT, INCIDENTAL, SPECIAL, EXEMPLARY, OR CONSEQUENTIAL DAMAGES (INCLUDING, BUT NOT LIMITED TO, PROCUREMENT OF SUBSTITUTE GOODS OR SERVICES; LOSS OF USE, DATA, OR PROFITS; OR BUSINESS INTERRUPTION) HOWEVER CAUSED AND ON ANY THEORY OF LIABILITY, WHETHER IN CONTRACT, STRICT LIABILITY, OR TORT (INCLUDING NEGLIGENCE OR OTHERWISE) ARISING IN ANY WAY OUT OF THE USE OF THIS SOFTWARE, EVEN IF ADVISED OF THE POSSIBILITY OF SUCH DAMAGE.

- libogg

Copyright (c) 2002, Xiph.org Foundation  
Redistribution and use in source and binary forms, with or without modification, are permitted provided that the following conditions are met:

- Redistributions of source code must retain the above copyright notice, this list of conditions and the following disclaimer.
- Redistributions in binary form must reproduce the above copyright notice, this list of conditions and the following disclaimer in the documentation and/or other materials provided with the distribution.
- Neither the name of the Xiph.org Foundation nor the names of its contributors may be used to endorse or promote products derived from this software without specific prior written permission.

THIS SOFTWARE IS PROVIDED BY THE COPYRIGHT HOLDERS AND CONTRIBUTORS "AS IS" AND ANY EXPRESS OR IMPLIED WARRANTIES, INCLUDING, BUT NOT LIMITED TO, THE IMPLIED WARRANTIES OF MERCHANTABILITY AND FITNESS FOR A PARTICULAR PURPOSE ARE DISCLAIMED. IN NO EVENT SHALL THE FOUNDATION OR CONTRIBUTORS BE LIABLE FOR ANY DIRECT, INDIRECT, INCIDENTAL, SPECIAL, EXEMPLARY, OR CONSEQUENTIAL DAMAGES (INCLUDING, BUT NOT LIMITED TO, PROCUREMENT OF SUBSTITUTE GOODS OR SERVICES; LOSS OF USE, DATA, OR PROFITS; OR BUSINESS INTERRUPTION) HOWEVER CAUSED AND ON ANY THEORY OF LIABILITY, WHETHER IN CONTRACT, STRICT LIABILITY, OR TORT (INCLUDING NEGLIGENCE OR OTHERWISE) ARISING IN ANY WAY OUT OF THE USE OF THIS SOFTWARE, EVEN IF ADVISED OF THE POSSIBILITY OF SUCH DAMAGE.

## Information on Disposal of Old Electrical and Electronic Equipment and Batteries (applicable for EU countries that have adopted separate waste collection systems)

Products and batteries with the symbol (crossed-out wheeled bin) cannot be disposed as household waste.

Old electrical and electronic equipment and batteries should be recycled at a facility capable of handling these items and their waste byproducts.

Contact your local authority for details in locating a recycle facility nearest to you.

Proper recycling and waste disposal will help conserve resources whilst preventing detrimental effects on our health and the environment.

Notice: The sign "Pb" below the symbol for batteries indicates that this battery contains lead.



### מידע בדבר השלכה לאשפה של ציוד חשמלי ואלקטרוני ישן וכן סוללות (רלוונטי למדינות שמשמשות במערכת איסוף אשפה מופרדת).

לא ניתן להשליך מוצרים וסוללות עם הסימון (פח אשפה עם עליון) כאשפה ביתית רגילה.

יש למחזר ציוד חשמלי ואלקטרוני ישן וכן סוללות במתקן המסוגל לטפל בפריטים כאלה ובתוצרי הלוואי שלהם.

צרו קשר עם הרשות המקומית לקבלת פרטים אודות מתקן המיחזור הקרוב אליכם. מיחזור והשלכה לאשפה מאותם יעזרו לשמר משאבים ולמנוע השפעות שליליות על בריאותנו ועל הסביבה.

שימו לב: הסימון Pb שמתחת לסימון עובר סוללות מציינ שהסוללה מכילה עופרת.

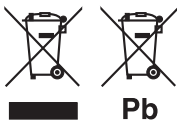

### Declaration of Conformity with regard to the RE Directive 2014/53/EU

### Declaration of Conformity with regard to the RoHS Directive 2011/65/EU

#### Manufacturer:

JVCKENWOOD Corporation  
3-12, Moriyacho, Kanagawa-ku, Yokohama-shi,  
Kanagawa 221-0022, JAPAN

#### EU Representative:

JVCKENWOOD Europe B.V.  
Amsterdamseweg 37, 1422 AC UITHOORN, THE  
NETHERLANDS

#### English

Hereby, JVCKENWOOD declares that the radio equipment DMX8020DABS / DMX7520DABS is in compliance with Directive 2014/53/EU. The full text of the EU declaration of conformity is available at the following internet address:

#### Français

Par la présente, JVCKENWOOD déclare que l'équipement radio DMX8020DABS / DMX7520DABS est conforme à la directive 2014/53/UE. L'intégralité de la déclaration de conformité UE est disponible à l'adresse Internet suivante :

#### Deutsch

Hiermit erklärt JVCKENWOOD, dass das Funkgerät DMX8020DABS / DMX7520DABS der Richtlinie 2014/53/EU entspricht. Der volle Text der EU-Konformitätserklärung steht unter der folgenden Internetadresse zur Verfügung:

#### Nederlands

Hierbij verklaart JVCKENWOOD dat de radioapparatuur DMX8020DABS / DMX7520DABS in overeenstemming is met Richtlijn 2014/53/EU. De volledige tekst van de EU-verklaring van overeenstemming is te vinden op het volgende internetadres:

#### Italiano

Con la presente, JVCKENWOOD dichiara che l'apparecchio radio DMX8020DABS / DMX7520DABS è conforme alla Direttiva 2014/53/UE. Il testo integrale della dichiarazione di conformità UE è disponibile al seguente indirizzo internet:

#### Español

Por la presente, JVCKENWOOD declara que el equipo de radio DMX8020DABS / DMX7520DABS cumple la Directiva 2014/53/EU. El texto completo de la declaración de conformidad con la UE está disponible en la siguiente dirección de internet:

#### Português

Deste modo, a JVCKENWOOD declara que o equipamento de rádio DMX8020DABS / DMX7520DABS está em conformidade com a Diretiva 2014/53/UE. O texto integral da declaração de conformidade da UE está disponível no seguinte endereço de internet:

#### Polska

Niniejszym, JVCKENWOOD deklaruje, że sprzęt radiowy DMX8020DABS / DMX7520DABS jest zgodny z dyrektywą 2014/53/UE. Pełny tekst deklaracji zgodności EU jest dostępny pod adresem:

#### Česky

Společnost JVCKENWOOD tímto prohlašuje, že rádiové zařízení DMX8020DABS / DMX7520DABS splňuje podmínky směrnice 2014/53/EU. Plný text EU prohlášení o shodě je dostupný na následující internetové adrese:

## Appendix

### Magyar

JVCケンウッド ezennel kijelenti, hogy a DMX8020DABS / DMX7520DABS rádióberendezés megfelel a 2014/53/EU irányelvnek. Az EU konformitási nyilatkozat teljes szövege az alábbi weboldalon érhető el:

### Hrvatski

JVCケンウッド ovim izjavljuje da je radio oprema DMX8020DABS / DMX7520DABS u skladu s Direktivom 2014/53/EU. Cjeloviti tekst deklaracije Europske unije o usklađenosti dostupan je na sljedećoj internet adresi:

### Svenska

Härmed försäkras JVCケンWOOD att radioutrustningen DMX8020DABS / DMX7520DABS är i enlighet med direktiv 2014/53 / EU. Den fullständiga texten av EU-försäkran om överensstämmelse finns på följande Internetadress:

### Suomi

JVCケンWOOD julistaa täten, että radiolaitte DMX8020DABS / DMX7520DABS on direktiivin 2014/53/EU mukainen. EU-vaatimustenmukaisuusvakuutus löytyy kokonaisuudessaan seuraavasta internet-osoitteesta:

### Slovensko

S tem JVCケンWOOD izjavlja, da je radijska oprema DMX8020DABS / DMX7520DABS v skladu z Direktivo 2014/53/EU. Celotno besedilo direktive EU o skladnosti je dostopno na tem spletnem naslovu:

### Slovensky

Spoločnosť JVCケンWOOD týmto vyhlasuje, že rádiové zariadenie DMX8020DABS / DMX7520DABS vyhovuje smernici 2014/53/EU. Celý text EÚ vyhlásenia o zhode nájdete na nasledovnej internetovej adrese:

### Dansk

Herved erklærer JVCケンWOOD, at radioudstyret DMX8020DABS / DMX7520DABS er i overensstemmelse med Direktiv 2014/53/EU. EU-overensstemmelseserklæringens fulde ordlyd er tilgængelig på følgende internetadresse:

### Norsk

JVCケンWOOD erklærer herved at radioutstyret DMX8020DABS / DMX7520DABS er i samsvar med Direktiv 2014/53/EU. Den fullstendige teksten til EU-konformitetserklæringen er tilgjengelig på følgende internetadresse:

### Ελληνικά

Με το παρόν, η JVCケンWOOD δηλώνει ότι ο ραδιοεξοπλισμός DMX8020DABS / DMX7520DABS συμμορφώνεται με την Οδηγία 2014/53/ΕΕ. Το πλήρες κείμενο της δήλωσης συμμόρφωσης της ΕΕ είναι διαθέσιμο στην ακόλουθη διεύθυνση στο διαδίκτυο:

### Eesti

Käesolevaga JVCケンWOOD kinnitab, et DMX8020DABS / DMX7520DABS raadiovarustus on vastavuses direktiiviiga 2014/53/ EL. ELi vastavusdeklaratsiooni terviktekst on kättesaadav järgmisel internetiaadressil:

### Latviešu

JVCケンWOOD ar šo deklarē, ka radio aparatūra DMX8020DABS / DMX7520DABS atbilst direktīvas 2014/53/ES prasībām. Pilns ES atbilstības deklarācijas teksts ir pieejams šādā tīmekļa adresē:

### Lietuviškai

Šiuo JVCケンWOOD pažymi, kad radijo įranga DMX8020DABS / DMX7520DABS atitinka 2014/53/EB direktyvos reikalavimus. Visą EB direktyvos atitikties deklaracijos tekstą galite rasti šiuo internetiniu adresu:

### Malti

B'dan, JVCケンWOOD jiddikjara li t-tagħmir tar-radjju DMX8020DABS / DMX7520DABS huwa konformi ma'd-Direttiva 2014/53/UE. It-test kollu tad-dikjarazzjoni ta' konformità huwa disponibbli fl-indirizz intranet li ġej:

### Українська

Таким чином, компанія JVCケンWOOD заявляє, що радіообладнання DMX8020DABS / DMX7520DABS відповідає Директиві 2014/53/ЄУ. Повний текст декларації про відповідність ЄС можна знайти в Інтернеті за такою адресою:

### Türkçe

Burada, JVCケンWOOD DMX8020DABS / DMX7520DABS radyo ekipmanının 2014/53/AB Direktifine uygun olduğunu bildirir. AB uyumluluk deklarasyonunun tam metni aşağıdaki internet adresinde mevcuttur.

### Русский

JVCケンWOOD настоящим заявляет, что радиооборудование DMX8020DABS / DMX7520DABS соответствует Директиве 2014/53/ EU. Полный текст декларации соответствия ЕС доступен по следующему адресу в сети Интернет:

### Limba română

Prin prezenta, JVCケンWOOD declară că echipamentul radio DMX8020DABS / DMX7520DABS este în conformitate cu Directiva 2014/53/UE. Textul integral al declarației de conformitate UE este disponibil la următoarea adresă de internet:

### Български език

С настоящото JVCケンWOOD декларира, че радиооборудването на DMX8020DABS / DMX7520DABS е в съответствие с Директива 2014/53/ЕС. Пълният текст на ЕС декларацията за съответствие е достъпен на следния интернет адрес:

**URL: <https://www.kenwood.com/cs/ce/eudoc/>**



---

**KENWOOD**