

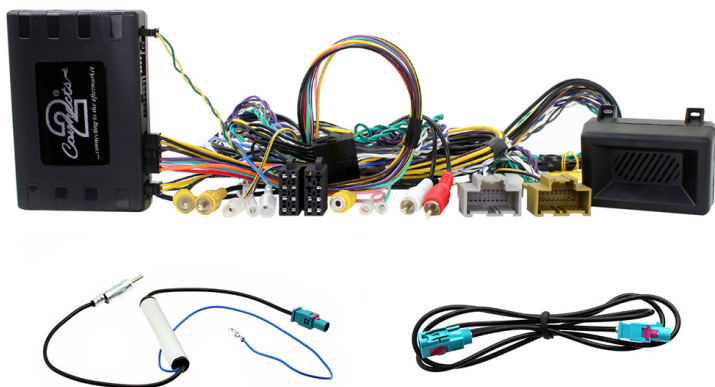

**CTUVX04**  
**VAUXHALL/OPEL INFODAPTER**  
Astra 2015>



**INSTRUCTION MANUAL**

*[www.connects2.com](http://www.connects2.com)*

Designed and  
Engineered  
in the UK. 

# ABOUT

The Connects2 Infodapter for Vauxhall vehicles allows vehicle setting and parking sensor information to be displayed on any aftermarket head unit with rear camera input. The Infodapter also allows the use of the steering wheel controls with almost every steering wheel control compatible head unit on the market.

NB: Allows use of steering wheel controls, optical parking sensor display and climate control visualisation. Does not retain Onstar, rain sense wipers or remote window operation.

# DIP SWITCH SETTINGS

See Fig 1.

Up = Off, Down = On

1: On = Pioneer head units. Off = All other head units

2: Setting for reverse camera. On = PAL, Off = NTSC. The default setting is Off (NTSC).

3: Resets the display settings back to default. If the display settings have been manipulated in a way that it is no longer possible to make adjustments, change the DIP switch #3 from Off to On and back. This will reset the screen settings to the factory defaults. During this procedure the screen background will change to red. While the background is red, no settings can be made.

4: Not applicable

# Interface Connections

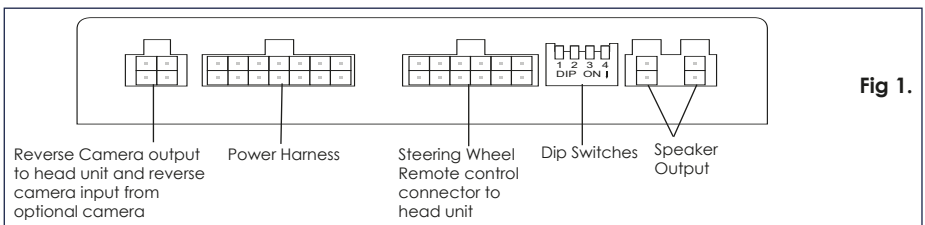

Fig 1.

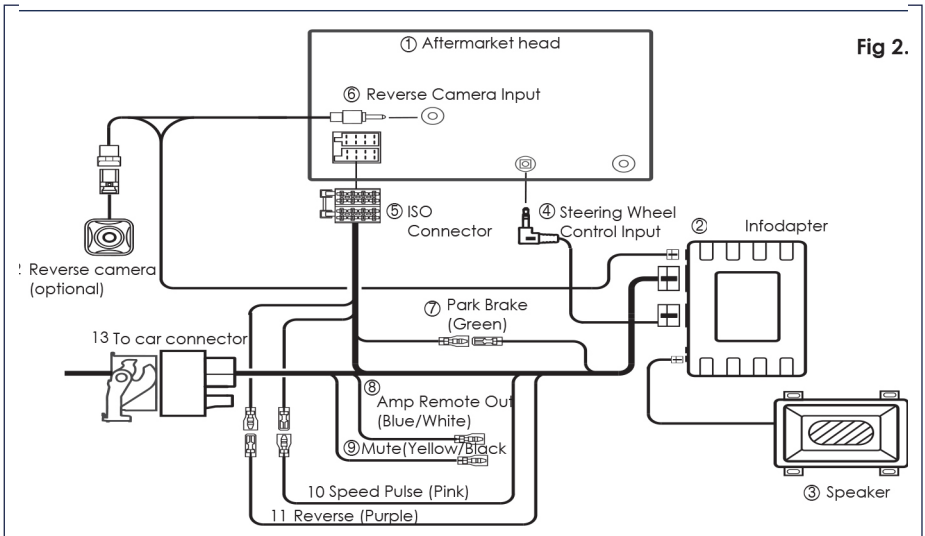

Fig 2.

# Interface Connections

## Connection of the Main Loom & Antenna

NB: The OEM radio is located underneath the right hand footwell. Locate this before attempting installation

Connect the main loom as shown in Fig. 2,

The OEM radio may have two antenna connections (DAB & FM). Locate the FM connector (usually black) and connect the CT27AA17 extension to it. Then connect the CT27AA14 adapter to the extension and route both the main loom and antenna lead up to the new radio location.

Connect the blue wire on the CT27AA14 to a switched 12v supply if the roof antenna requires a 12v supply to switch on the amplifier. A switched 12v supply will be found on the new radio, normally labelled "Antenna Remote".

## Steering Wheel Controls

Fig 3.

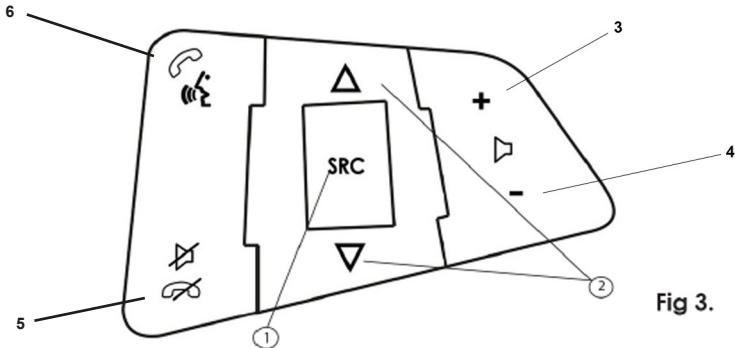

Fig 3.

1. Source
2. Track +/-
3. Volume +
4. Volume -
5. Speech/Pick Up
6. Mute/Hang Up

# Configuration Menu...continued

---

To access the menu, **push and hold the source button** for 2 seconds (Fig. 3). This will enable the configuration menu. To navigate through the menu options use the **Track Up/Track Down buttons**. To select a menu option, push the **source button once**.

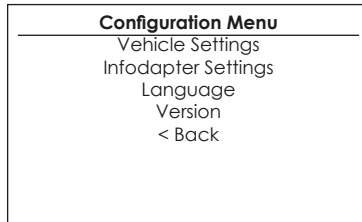

- **Vehicle Settings**  
Vehicle settings can be adjusted via the menu. All vehicle setup options that were available with the original head unit, are now available through the aftermarket head unit. See the vehicle handbook for more information regarding these features.

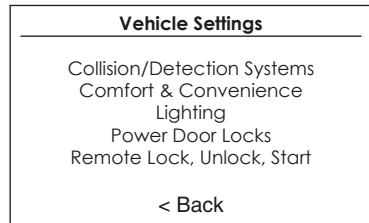

- **Collision/Detection Systems**  
Set Park Assist to 'On' or 'Off'

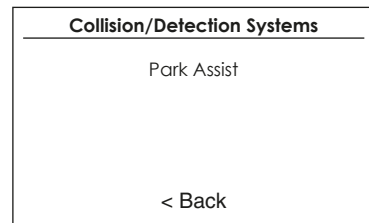

- **Comfort & Convenience**  
Set Chime Volume (+/-)  
Driver Personalisation 'On' or 'Off'  
Auto Wipe 'On' or 'Off'

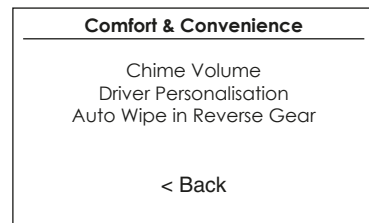

# Configuration Menu...continued

---

- **Lighting**

Vehicle Locator Lights 'On' or 'Off'  
Exit Lighting 'Off', '30 Seconds', '60  
Seconds', '120 Seconds'

Lighting
Vehicle Locator Lights Exit Lighting
< Back

- **Power Door Locks**

Unlocked Door Anti Lock Out 'On' or  
'Off'  
Auto Door Lock 'On' or 'Off'

Power Door Locks
Unlocked Door Anti Lock Out Auto Door Lock
< Back

- **Remote Lock, Unlock, Start**

Remote Unlock Light Feedback 'Off' or  
'Flash'  
Remote Door Unlock 'All' or 'Drivers'  
Relock Remotely Unlocked Doors 'On'  
or 'Off'

Remote Lock, Unlock, Start
Remote Unlock Light Feedback Remote Door Unlock Relock Remotely Unlocked Doors
< Back

# Configuration Menu...continued

- **Infodapter Settings**

- Screen Size/Position - Make sure all 4 corner markers are touching the corners of the aftermarket head unit display.

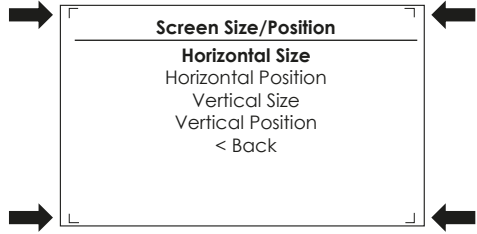

- Picture Settings - Adjust Brightness, contrast and colour saturation.

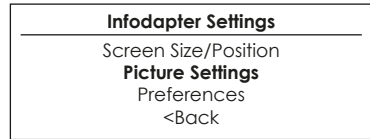

- Preferences -

**Driver Position** - Select Left or Right depending on vehicle configuration

**Park Assist Version** - Select according to the colour configuration of the park assist fitted to the vehicle

**Camera Connected** - Select Yes if an optional camera is connected

**Reverse Priority\*** - Select which image (Camera or Park Assist) will be shown by default when reversing. The driver can select the desired image by pushing the Source button (Fig.3) while reversing. (\*Note: this option is only available when 'Camera Connected' is set to Yes)

**Park Brake Source** - Set to Speed, Brake or Always On

**Bluetooth** - Select On if aftermarket head unit has Bluetooth built in. Pick up/hang up buttons on the steering wheel will be enabled

**Steering Wheel** - Select 6 or 7 function type depending upon vehicle

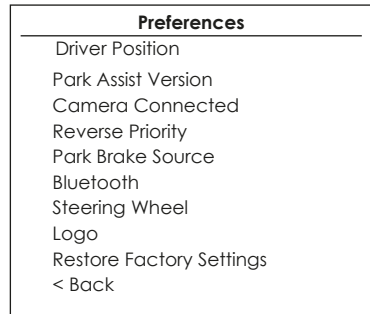

## Configuration Menu...continued

---

- Preferences -

**Logo\*** - Select for relevant vehicle or head unit brand logo to be shown on the dash display. (\*Note that this option will only appear for support four line dash displays. OEM navigation display is not supported)

**Restore Factory Settings** - Reverts all Infodapter settings to factory defaults. (This does not restore vehicle settings)

### Legal Information

Please consult the relevant road traffic laws governing the country in which this product is being operated. No liability is accepted for material damage, loss or personal injury, directly or indirectly, from installation and operation of this product. This product should only be operated when safe to do so.

